

Dell™ Axim™ X50

# Owner's Manual

**Models HC03U, HC03UL, and HD04U**

[www.dell.com](http://www.dell.com) | [support.dell.com](http://support.dell.com)

# Notes, Notices, and Cautions



**NOTE:** A NOTE indicates important information that helps you make better use of your computer.



**NOTICE:** A NOTICE indicates either potential damage to hardware or loss of data and tells you how to avoid the problem.



**CAUTION:** A CAUTION indicates a potential for property damage, personal injury, or death.

# Abbreviations and Acronyms

For a complete list of abbreviations and acronyms, see the "Glossary" on page 167.

---

**Information in this document is subject to change without notice.  
© 2004 Dell Inc. All rights reserved.**

Reproduction in any manner whatsoever without the written permission of Dell Inc. is strictly forbidden.

Trademarks used in this text: *Dell*, the *DELL* logo, *Axim*, *TrueMobile*, *Dimension*, *Inspiron*, *OptiPlex*, *Latitude*, *Dell Precision*, *PowerApp*, *PowerVault*, *PowerEdge*, *PowerConnect*, and *DellNet* are trademarks of Dell Inc.; *Intel*, *Pentium*, and *Celeron* are registered trademarks and *XScale* and *StrataFlash* are trademarks of Intel Corporation; *Microsoft*, *Windows*, *Windows Media*, and *ActiveSync* are registered trademarks and *Windows Mobile* is a trademark of Microsoft Corporation; *Bluetooth* is a registered trademark owned by Bluetooth SIG, Inc. and is used by Dell Inc. under license.

Other trademarks and trade names may be used in this document to refer to either the entities claiming the marks and names or their products. Dell Inc. disclaims any proprietary interest in trademarks and trade names other than its own.

**Models HC03U, HC03UL, and HD04U**

September 2004

P/N N6966

Rev. A01

# Contents

<b>CAUTION: Safety Instructions</b> . . . . .	<b>11</b>
SAFETY: General . . . . .	11
SAFETY: Power . . . . .	12
SAFETY: Battery . . . . .	12
SAFETY: Air Travel . . . . .	13
SAFETY: Electromagnetic Compatibility Instructions . . . . .	13
<b>When Using Your Device</b> . . . . .	<b>13</b>
SAFETY: Ergonomic Computing Habits . . . . .	14
SAFETY: Protecting Against Electrostatic Discharge . . . . .	14
SAFETY: Battery Disposal . . . . .	15
<b>Finding Information</b> . . . . .	<b>15</b>

## 1 About Your Device

<b>Front, Side, and Back Views</b> . . . . .	<b>17</b>
Front and Side Views . . . . .	17
Back View . . . . .	19
<b>Using the Battery</b> . . . . .	<b>20</b>
Installing and Removing the Battery . . . . .	20
Charging the Battery . . . . .	22

<b>Connecting to a Computer</b> . . . . .	<b>23</b>
Using the Cradle . . . . .	23
USB Charging . . . . .	26
Using the Sync Cable . . . . .	27
<b>Connecting to a Projector</b> . . . . .	<b>28</b>
<b>Checking Built-In Storage</b> . . . . .	<b>29</b>
<b>Using Cards</b> . . . . .	<b>29</b>
CompactFlash Cards . . . . .	29
Secure Digital Memory Cards . . . . .	31
<b>Performing a Reset</b> . . . . .	<b>32</b>
Soft Reset . . . . .	32
Hard Reset . . . . .	33

## 2 Using Microsoft® Windows Mobile™ 2003 Second Edition

<b>Device Buttons and the Reset Stylus</b> . . . . .	<b>35</b>
<b>Today Screen</b> . . . . .	<b>35</b>
<b>Status Icons</b> . . . . .	<b>36</b>
<b>Programs</b> . . . . .	<b>38</b>
Program Buttons . . . . .	38
Switcher Bar . . . . .	38
<b>Navigation Bar and Command Bar</b> . . . . .	<b>40</b>
<b>Pop-Up Menus</b> . . . . .	<b>41</b>

<b>Finding and Organizing Information</b> . . . . .	<b>41</b>
---	-----------

<b>Backing Up Data</b> . . . . .	<b>42</b>
----------------------------------	-----------

### **3 Entering Information**

<b>Entering Text Using the Input Panel</b> . . . . .	<b>43</b>
--	-----------

Typing With the Soft Keyboard . . . . .	44
---	----

Letter Recognizer . . . . .	45
-----------------------------	----

Block Recognizer . . . . .	45
----------------------------	----

Transcriber . . . . .	45
-----------------------	----

Editing Typed Text . . . . .	46
------------------------------	----

<b>Writing on the Screen</b> . . . . .	<b>46</b>
--	-----------

Editing Written Text . . . . .	47
--------------------------------	----

<b>Drawing on the Screen</b> . . . . .	<b>50</b>
--	-----------

Creating a Drawing . . . . .	50
------------------------------	----

Editing a Drawing . . . . .	51
-----------------------------	----

<b>Recording a Message</b> . . . . .	<b>51</b>
--------------------------------------	-----------

<b>Using My Text</b> . . . . .	<b>52</b>
--------------------------------	-----------

### **4 Adjusting Settings**

<b>Personal Tab</b> . . . . .	<b>53</b>
-------------------------------	-----------

<b>System Tab</b> . . . . .	<b>53</b>
-----------------------------	-----------

<b>Connections Tab</b> . . . . .	<b>54</b>
----------------------------------	-----------

## 5 Using the Microsoft® ActiveSync® Program

<b>About ActiveSync</b> . . . . .	<b>55</b>
<b>Installing and Using ActiveSync</b> . . . . .	<b>56</b>

## 6 Scheduling and Communicating

<b>About Microsoft® Pocket Outlook</b> . . . . .	<b>57</b>
<b>Calendar</b> . . . . .	<b>57</b>
Using the Summary Screen . . . . .	59
Creating Meeting Requests . . . . .	59
<b>Contacts</b> . . . . .	<b>60</b>
Finding a Contact . . . . .	61
Using the Summary Screen . . . . .	61
<b>Tasks</b> . . . . .	<b>61</b>
<b>Notes</b> . . . . .	<b>63</b>
<b>Messaging</b> . . . . .	<b>64</b>
Synchronizing E-Mail Messages . . . . .	64
Connecting Directly to an E-Mail Server . . . . .	64
Using the Message List . . . . .	65
Composing Messages . . . . .	67
Managing E-Mail Messages and Folders . . . . .	68
<b>Notifications</b> . . . . .	<b>69</b>

## 7 Adding and Removing Programs

<b>Adding Programs Using Microsoft® ActiveSync®</b> . . . . .	<b>71</b>
<b>Downloading Programs From the Internet</b> . . . . .	<b>72</b>
<b>Adding a Program to the Start Menu</b> . . . . .	<b>73</b>
Using File Explorer on the Device . . . . .	73
Using ActiveSync on the Computer . . . . .	73
<b>Error Message When Installing Software</b> . . . . .	<b>74</b>
Changing the Display Mode on Your Device . . . . .	74
<b>File Download Security Warning</b> . . . . .	<b>75</b>
<b>Removing Programs</b> . . . . .	<b>75</b>

## 8 Using Companion Programs

<b>Microsoft® Pocket Word</b> . . . . .	<b>77</b>
<b>Pocket Excel</b> . . . . .	<b>79</b>
Tips for Working in Pocket Excel . . . . .	81
<b>MSN Messenger</b> . . . . .	<b>81</b>
Setting Up . . . . .	82
Working With Contacts . . . . .	82
Chatting With Contacts . . . . .	83
<b>Microsoft Windows Media® Player for Pocket PC</b> . . . . .	<b>83</b>

## 9 Using Microsoft® Pocket Internet Explorer

<b>Mobile Favorites</b> . . . . .	<b>85</b>
Conserving Memory . . . . .	86
Mobile Favorites Folder . . . . .	86
Favorite Links . . . . .	87
<b>Using AvantGo Channels</b> . . . . .	<b>87</b>
<b>Browsing Mobile Favorites and the Web</b> . . . . .	<b>88</b>

## 10 Getting Connected

<b>Using Infrared</b> . . . . .	<b>91</b>
<b>Using Bluetooth® Wireless Technology</b> . . . . .	<b>92</b>
<b>Using Wi-Fi (802.11b)</b> . . . . .	<b>92</b>
<b>Creating a Modem Connection</b> . . . . .	<b>94</b>
<b>Creating an Ethernet Connection</b> . . . . .	<b>95</b>
<b>Creating a VPN Connection</b> . . . . .	<b>96</b>
<b>Ending a Connection</b> . . . . .	<b>97</b>
<b>Connecting Directly to an E-Mail Server</b> . . . . .	<b>97</b>
<b>Getting Help on Connecting</b> . . . . .	<b>98</b>

## 11 Appendix

<b>Specifications</b> . . . . .	<b>99</b>
<b>U.S. Terms and Conditions of Sale</b> . . . . .	<b>104</b>



<b>Dell™ Software License Agreement</b> . . . . .	<b>107</b>
<b>Regulatory Notices</b> . . . . .	<b>110</b>
FCC Notices (U.S. Only) . . . . .	111
IC Notice (Canada Only) . . . . .	112
CE Notice (European Union) . . . . .	112
CE Mark Notice . . . . .	114
Australia and New Zealand . . . . .	114
VCCI Notice (Japan Only) . . . . .	115
MIC Notice (Republic of Korea Only) . . . . .	116
Polish Center for Testing and Certification Notice . . . . .	116
NOM Information (Mexico Only) . . . . .	119
<b>Wireless Regulatory Information</b> . . . . .	<b>119</b>
Europe—CE Declaration of Conformity . . . . .	120
Japan Standard . . . . .	122
Canada—Industry Canada (IC) . . . . .	123
FCC Standard . . . . .	123
Mexico . . . . .	124
Singapore—Approved by IDA for Use in Singapore . . . . .	124
Korea . . . . .	124
Brazil . . . . .	125
Radio Approvals . . . . .	125
<b>Contacting Dell</b> . . . . .	<b>125</b>

<b>Limited Warranties</b> . . . . .	<b>153</b>
Limited Warranty for Dell-Branded Hardware Products (U.S. Only) . . . . .	153
Total Satisfaction Return Policy (U.S. Only) . . . . .	157
Limited Warranty Terms for Dell-Branded Hardware Products (Canada Only) . . . . .	158
"Total Satisfaction" Return Policy (Canada Only) . . . . .	162
Dell Software and Peripherals (Canada Only) . . . . .	163
1-Year End-User Manufacturer Guarantee (Latin America and the Caribbean Only) . . . . .	164
<b>Glossary</b> . . . . .	<b>167</b>
 Index . . . . .	 169



## **CAUTION: Safety Instructions**

Use the following safety guidelines to help ensure your own personal safety and to help protect your device and working environment from potential damage.

### **SAFETY: General**

- Do not attempt to service the device yourself unless you are a trained service technician. Always follow installation instructions closely.
- If you use an extension power cable with your AC adapter, ensure that the total ampere rating of the products plugged in to the extension power cable does not exceed the ampere rating of the extension cable.
- Do not push objects into air vents or openings of your device. Doing so can cause fire or electric shock by shorting out interior components.
- Keep your device away from radiators and heat sources. Also, do not block cooling vents. Avoid placing loose papers underneath your device; do not place your device in a closed-in wall unit or on a bed, sofa, or rug.
- Place the AC adapter in a ventilated area, such as a desk top or on the floor, when you use it to run the device or to charge the battery. Do not cover the AC adapter with papers or other items that will reduce cooling; also, do not use the AC adapter inside a carrying case.
- The AC adapter may become hot during normal operation of your device. Use care when handling the adapter during or immediately after operation.
- Do not use your device in a wet environment, for example, near a bath tub, sink, or swimming pool or in a wet basement.
- If your device includes an integrated or optional (PC Card) modem, disconnect the modem cable if an electrical storm is approaching to avoid the remote risk of electric shock from lightning via the telephone line.
- To help avoid the potential hazard of electric shock, do not connect or disconnect any cables or perform maintenance or reconfiguration of this product during an electrical storm. Do not use your device during an electrical storm unless all cables have been disconnected and the device is operating on battery power.
- If your device includes a modem, the cable used with the modem should be manufactured with a minimum wire size of 26 American wire gauge (AWG) and an FCC-compliant RJ-11 modular plug.
- PC Cards may become very warm during normal operation. Use care when removing PC Cards after their continuous operation.
- Before you clean your device, disconnect the device from the electrical outlet. Clean your device with a soft cloth dampened with water. Do not use liquid or aerosol cleaners, which may contain flammable substances.

## **SAFETY: Power**

- Use only the Dell-provided AC adapter approved for use with this device. Use of another AC adapter may cause a fire or explosion.
- Before you connect the device to an electrical outlet, check the AC adapter voltage rating to ensure that the required voltage and frequency match the available power source.
- To remove the device from all power sources, turn the device off, disconnect the AC adapter from the electrical outlet, and remove the battery installed in the battery bay.
- To help prevent electric shock, plug the AC adapter and device power cables into properly grounded power sources. These power cables may be equipped with 3-prong plugs to provide an earth grounding connection. Do not use adapter plugs or remove the grounding prong from the power cable plug. If you use a power extension cable, use the appropriate type, 2-prong or 3-prong, to mate with the AC adapter power cable.
- Be sure that nothing rests on your AC adapter's power cable and that the cable is not located where it can be tripped over or stepped on.
- If you are using a multiple-outlet power strip, use caution when plugging the AC adapter's power cable into the power strip. Some power strips may allow you to insert the plug incorrectly. Incorrect insertion of the power plug could result in permanent damage to your device, as well as risk of electric shock and/or fire. Ensure that the ground prong of the power plug is inserted into the mating ground contact of the power strip.

## **SAFETY: Battery**

- Use only Dell™ battery modules that are approved for use with this device. Use of other types may increase the risk of fire or explosion.
- Do not carry a battery pack in your pocket, purse, or other container where metal objects (such as car keys or paper clips) could short-circuit the battery terminals. The resulting excessive current flow can cause extremely high temperatures and may result in damage to the battery pack or cause fire or burns.
- The battery poses a burn hazard if you handle it improperly. Do not disassemble it. Handle a damaged or leaking battery pack with extreme care. If the battery is damaged, electrolyte may leak from the cells and may cause personal injury.
- Keep the battery away from children.
- Do not store or leave your device or battery pack near a heat source such as a radiator, fireplace, stove, electric heater, or other heat-generating appliance or otherwise expose it to temperatures in excess of 60°C (140°F). When heated to excessive temperatures, battery cells could explode or vent, posing a risk of fire.
- Do not dispose of your device's battery in a fire or with normal household waste. Battery cells may explode. Discard a used battery according to the manufacturer's instructions or contact your local waste disposal agency for disposal instructions. Dispose of a spent or damaged battery promptly.

## SAFETY: Air Travel

- Certain Federal Aviation Administration regulations and/or airline-specific restrictions may apply to the operation of your Dell device while you are on board an aircraft. For example, such regulations/restrictions may prohibit the use of any personal electronic device (PED) that has the capacity for intentional transmission of radio frequency or other electromagnetic signals while on an aircraft.
  - In order to best comply with all such restrictions, if your Dell portable device is equipped with Dell TrueMobile™ or some other wireless communication device, please disable this device before you board the aircraft and follow all instructions provided by airline personnel with regard to such device.
  - Additionally, the use of any PED, such as a portable device, may be prohibited in aircraft during certain critical phases of flight, for example, takeoff and landing. Some airlines may further define the critical flight phase as any time the aircraft is below 3050 m (10,000 ft). Please follow the airline's specific instructions as to when the use of a PED is allowed.

## SAFETY: Electromagnetic Compatibility Instructions

Use shielded signal cables to ensure that you maintain the appropriate electromagnetic compatibility classification for the intended environment. For parallel printers, a cable is available from Dell. If you prefer, you can order a cable from Dell at its worldwide website at [www.dell.com](http://www.dell.com).

Static electricity can harm electronic components inside your device. To prevent static damage, discharge static electricity from your body before you touch any of your device's electronic components, such as a memory module. You can do so by touching an unpainted metal surface.

**WARNING:** Handling the cord on this product, or cords associated with accessories sold with this product, will expose you to lead, a chemical known to the State of California to cause birth defects or other reproductive harm. ***Wash your hands after handling the cord.***

## When Using Your Device

Observe the following safe-handling guidelines to prevent damage to your device:

- When setting up the device for work, place it on a level surface.
- When traveling, do not check the device as baggage. You can put your device through an X-ray security machine, but never put your device through a metal detector. If you have the device checked by hand, be sure to have a charged battery available in case you are asked to turn on the device.
- When traveling, do not place the device in overhead storage compartments where it could slide around. Do not drop your device or subject it to other mechanical shocks.
- Protect your device and battery from environmental hazards such as dirt, dust, food, liquids, temperature extremes, and overexposure to sunlight.

- When you move your device between environments with very different temperature and/or humidity ranges, condensation may form on or within the device. To avoid damaging the device, allow sufficient time for the moisture to evaporate before using the device.
-  **NOTICE:** When taking the device from low-temperature conditions into a warmer environment or from high-temperature conditions into a cooler environment, allow the device to acclimate to room temperature before turning on power.
- When you disconnect a cable, pull on its connector or on its strain-relief loop, not on the cable itself. As you pull out the connector, keep it evenly aligned to avoid bending any connector pins. Also, before you connect a cable make sure both connectors are correctly oriented and aligned.
  - Handle components with care. Hold a component such as a memory module by its edges, not its pins.
  - Clean the display with a soft, clean cloth and water. Apply the water to the cloth; then stroke the cloth across the display in one direction, moving from the top of the display to the bottom. Remove moisture from the display quickly and keep the display dry. Long-term exposure to moisture can damage the display. *Do not* use a commercial window cleaner to clean your display.

## SAFETY: Ergonomic Computing Habits



**CAUTION:** Improper or prolonged keyboard use may result in injury.



**CAUTION:** Viewing the display or external monitor screen for extended periods of time may result in eye strain.

## SAFETY: Protecting Against Electrostatic Discharge

Static electricity can harm electronic components inside your device. To prevent static damage, discharge static electricity from your body before you touch any of your device's electronic components, such as a memory module. You can do so by touching an unpainted metal surface.

You can also take the following steps to prevent damage from electrostatic discharge (ESD):

- When unpacking a static-sensitive component from its shipping carton, do not remove the component from the antistatic packing material until you are ready to install the component. Just before unwrapping the antistatic packaging, be sure to discharge static electricity from your body.
- When transporting a sensitive component, first place it in an antistatic container or packaging.
- Handle all sensitive components in a static-safe area. If possible, use antistatic floor pads and workbench pads.

## SAFETY: Battery Disposal



Your device uses a lithium-ion battery and a rechargeable NiMH battery. For instructions about replacing the batteries in your device, see "Using the Battery" on page 20.

Do not dispose of the battery along with household waste. Contact your local waste disposal agency for the address of the nearest battery deposit site.

## Finding Information

What Are You Looking For?	Find It Here:
How to set up my device and information on the connectors and buttons on my device	The setup diagram and the Dell™ <i>Owner's Manual</i>
Information on using my device	Dell <i>Owner's Manual</i> and Pocket PC Help To view Help, tap the <b>Start</b> button and tap <b>Help</b> .
Additional programs that can be installed on my device	<i>Dell Companion</i> CD
Information on using programs on my device	Pocket PC Help and, if available, tap <b>Help</b> within a specific program
Connecting to and synchronizing with a computer	Dell <i>Owner's Manual</i> and Microsoft® ActiveSync® <i>Help</i> on your computer To view <i>Help</i> , click <b>Help</b> and click <b>Microsoft ActiveSync Help</b> .
Last-minute updates and detailed technical information	The readme files, located in the <b>ActiveSync</b> folder on the computer and on the <i>Dell Companion</i> CD.
Up-to-date information on your Pocket PC	<a href="http://www.microsoft.com/windowsmobile">www.microsoft.com/windowsmobile</a>
My Service Tag	Label located in the battery slot (remove the battery)





# About Your Device

## Front, Side, and Back Views

 **CAUTION:** Before performing any of the procedures in this section, read and follow the safety instructions on page 11.

### Front and Side Views

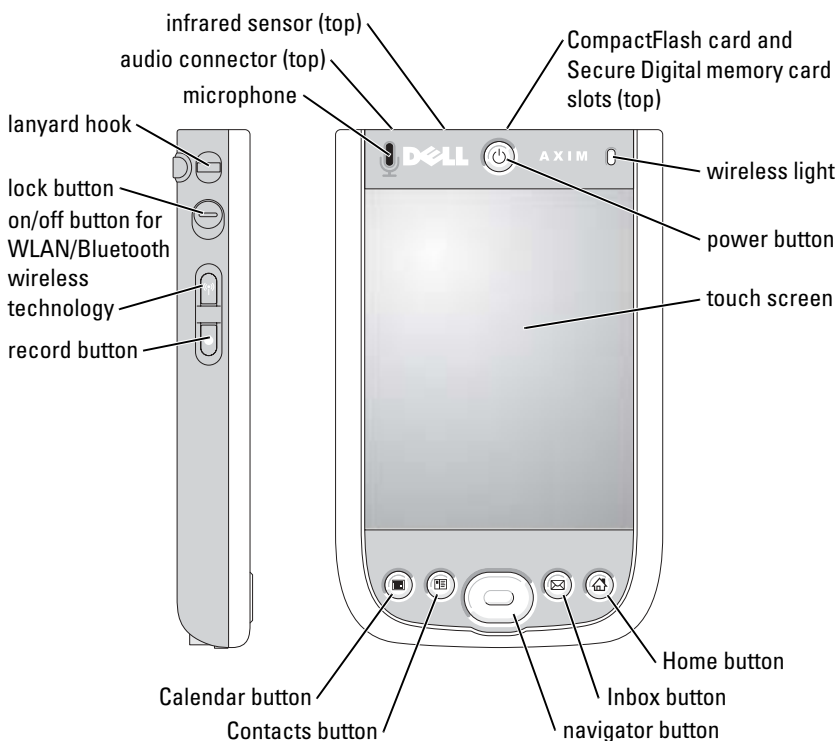

**INFRARED SENSOR** — The infrared sensor lets you transfer files from your device to another infrared-compatible device without using cable connections.

**MICROPHONE** — Allows you to record audio.

**COMPACTFLASH CARD AND SECURE DIGITAL MEMORY CARD SLOTS** — See "Using Cards" on page 29 for information on using CompactFlash cards and Secure Digital memory cards.

**POWER BUTTON** — Press the power button to turn the device on or off. Press and hold the power button to dim the display. Repeat to light the display.

- When the device is connected to external power and the main battery is fully charged, the power button light is solid green.
- When the main battery charge is low, the power button light flashes amber.
- When the battery is being charged, the power button light is solid amber.
- When the device relays a notification, the power button light rapidly flashes green.

**TOUCH SCREEN** — Use the touch screen and the reset stylus to enter information into your device. See "Entering Information" on page 43.

**ON/OFF BUTTON FOR WLAN/BLUETOOTH® WIRELESS TECHNOLOGY** — On wireless devices, the button turns both WLAN and Bluetooth wireless technology on and off. Turn off the wireless devices to conserve power. On non-WLAN devices, the button turns Bluetooth wireless technology on and off.

**HOME BUTTON** — Press to launch Home or to turn on the device.

**NAVIGATOR BUTTON** — Press the right, left, top, or bottom of the navigator button to move the cursor on the screen. Press the center to enter a selection.

**CONTACTS BUTTON** — Press to launch Contacts or to turn on the device.

**CALENDAR BUTTON** — Press to launch Calendar or to turn on the device.

**RECORD BUTTON** — See "Recording a Message" on page 51 for information on using the record button.

**LOCK BUTTON** — Allows you to lock the device so that the device does not respond to inadvertent pressing of keys.

## Back View

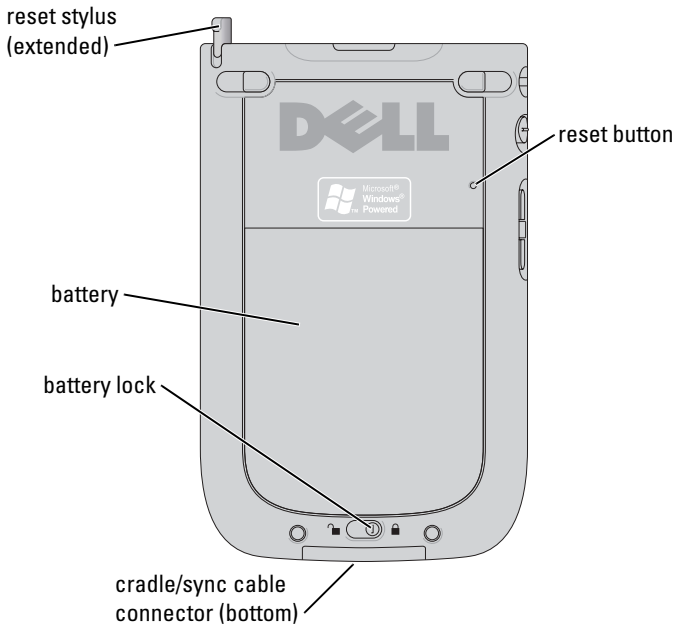

**BATTERY LOCK** — Use this switch to release and remove the main battery. See "Installing and Removing the Battery" on page 20.

**BATTERY** — See "Using the Battery" on page 20 for information on the main battery.

**CRADLE/SYNC CABLE CONNECTOR** — Connect a cradle or sync cable. See "Connecting to a Computer" on page 23.

**RESET BUTTON** — See "Performing a Reset" on page 32 for information on using the reset button.

**RESET STYLUS** — Use the reset stylus to write or draw on the screen. To remove the stylus, pull it straight up and out of the holder. To avoid losing the stylus, store the stylus in the holder when you are not using it. Ensure that the stylus is oriented correctly when you replace it in the slot.

## Using the Battery

- ➔ **NOTICE:** Do not use your device until you have charged the main battery for at least 8 hours for the first charge.

Before you use your device for the first time, you must install and charge the battery. Once the battery is charged, use the power properties to monitor the battery charge. See Pocket PC Help on the device for more information.

### Installing and Removing the Battery

To install the battery:

- 1 Ensure that the device is turned off.
- 2 Align the battery contacts with the contacts in the battery slot, insert the battery, and lower the battery into the slot until you feel a click.

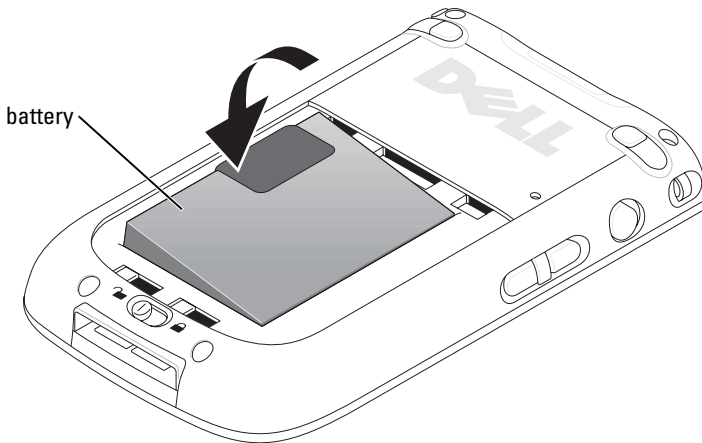

- 3 Close the battery cover.

- 4 Lock the battery cover by sliding the battery latch to the right.

 **NOTE:** The device turns on immediately once the battery is inserted and the battery cover latch is locked.

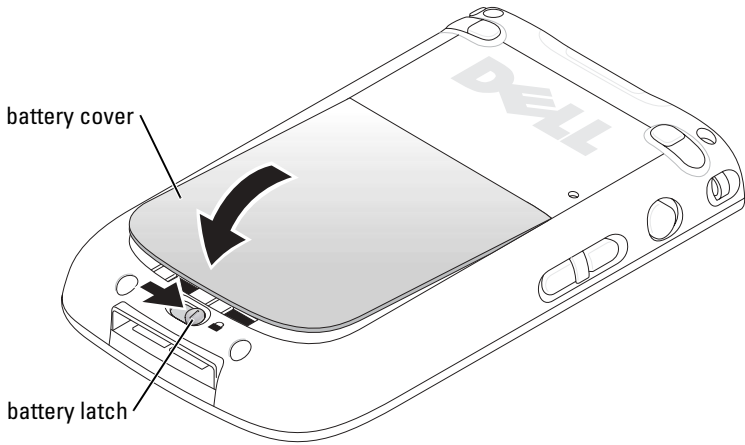

To remove the battery:

- 1 Slide the battery latch to the left to unlock the battery cover.
- 2 Lift the battery cover.

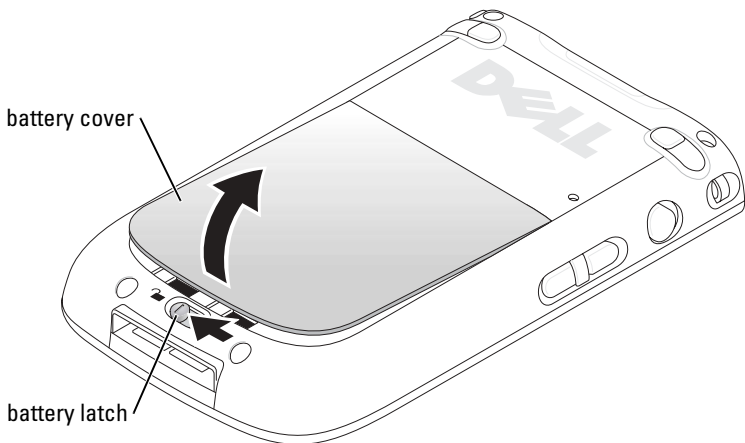

- 3 Pull the tab to lift the battery out of the slot.

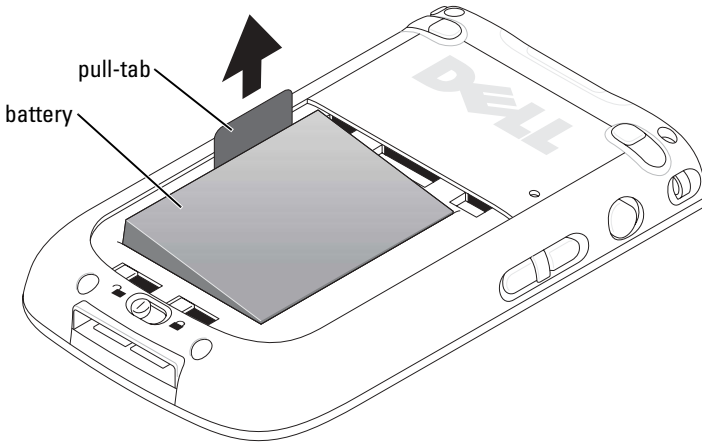

**NOTE:** Your Service Tag is located underneath the battery. You need your Service Tag if you access Dell Support at [support.dell.com](http://support.dell.com) or if you call Dell for customer service or technical support.

## Charging the Battery

Use one of the following options to charge the main battery:

- Connect the AC adapter directly to the charger adapter and then to the device and to an electrical outlet.
- Connect the AC adapter directly to the sync cable and then to the device and to an electrical outlet.
- Connect the AC adapter to the cradle, and insert the device into the cradle. See "Using the Cradle" on page 23 for more information.
- Connect the cradle with the device to a computer, which is connected to an electrical outlet. See "USB Charging" on page 26.

The standard battery pack (1100mAh) completely charges within 5 hours; the optional battery pack (2200mAh) completely charges within 10 hours.

If the main battery is critically low, the device enters "sleep" mode and the device turns off.

To recover from a critically low battery:

- 1 Plug in the AC adapter or replace the main battery with a charged battery.
- 2 Press the power button to turn on the device.

If you remove the main battery, the internal backup battery can last for up to 30 minutes in "sleep" mode. Do not remove the main battery if the backup battery power is low.

By default, the device turns off if the device is left unused for a period of time. See "System Tab" on page 53 for information about **Power** to set the amount of time during which the device can remain idle before it turns off.

## Connecting to a Computer

You either connect your device to a computer using a cradle or directly to a computer using a sync cable. Connect your device to a computer to:

- Add programs to your device. See "Adding Programs Using Microsoft® ActiveSync®" on page 71 for more information.
- Synchronize data on your device with data on your computer.

For information on synchronizing your data, see the following resources:

- "Using the Microsoft® ActiveSync® Program" on page 55
- ActiveSync Help on your computer
- ActiveSync Help on your device

### Using the Cradle



**NOTE:** Depending on the configuration of your device, the cradle is optional.

You can use the cradle to:

- Synchronize the data on your device with the data on your computer.
- Connect the device to an electrical outlet to conserve battery power.
- Charge the main battery. See "Using the Battery" on page 20 for more information.
- Charge a spare battery.



**NOTE:** Before connecting your device to a computer for the first time, install ActiveSync on the computer using the *Dell™ Companion* CD.

To connect your device to the cradle:

- 1** Place the cradle on a level surface near your computer.
- 2** Connect the cradle cable to the USB connector on your computer.
- 3** Connect the AC adapter to the cradle and to an electrical outlet.

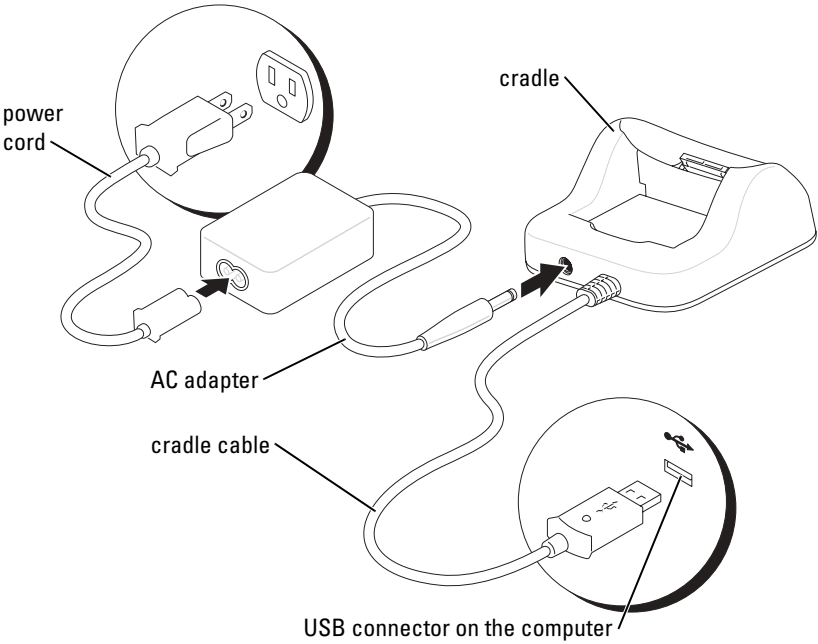



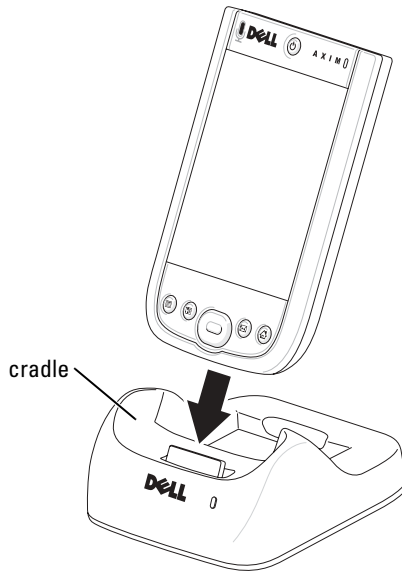

- 4 Align the connector on the bottom of the device with the connector on the cradle, and, keeping the front of the device flush with the front of the cradle, lower the device onto the cradle.

When the device is docked in the cradle, the connection status icon appears on the command bar (see page 36).

The spare battery status light on the cradle operates as follows:

- Green — The spare battery is fully charged.
- Amber — The spare battery is charging.



**NOTE:** The power button on the device indicates the charge status of the main battery. See the description of the power button lights on page 18 for more information.

To remove the device from the cradle, pull the device straight up and out of the cradle.

## USB Charging

You can charge your device battery when the cradle with the device is connected to a computer by a USB cable, and the computer is plugged into an electrical outlet and turned on.



**NOTE:** USB charging will not take place if the device is turned on.

You can charge the battery using a 5V/500mA USB port when the device is turned off.



**NOTE:** Using an external USB hub with 5V/100mA ports to charge the device battery may cause a temporary voltage drop in the hub, and other USB devices connected to the ports on the hub may not work normally until the device is removed.



**NOTE:** Charging the battery through a USB port takes more time than direct AC adapter charging.

The device charger stops the charging process after 7 hours. If you need more than 7 hours to charge the device battery, disconnect and reconnect the USB cable to restart the charging process.

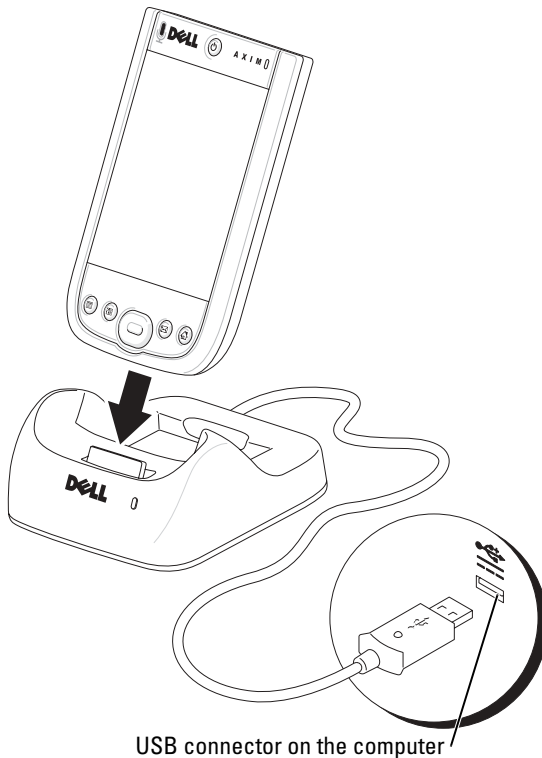

## Using the Sync Cable

Use the sync cable to connect your device directly to the computer without using the cradle.

 **NOTE:** Depending on the configuration of your device, the sync cable is optional.

To connect the sync cable:

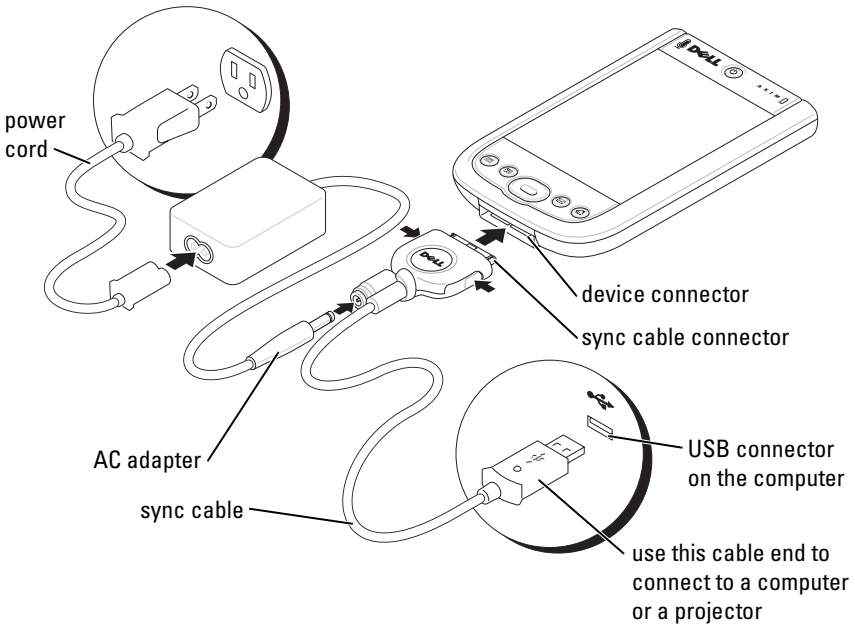

- 1 Connect one end of the cable to the USB connector on your computer.
- 2 Connect the other end of the cable to your device.

 **NOTICE:** To avoid damaging the connector, press the two buttons on the sides of the connector to release the self-lock structure before pulling the connector out of the device.



## Connecting to a Projector

You can connect the device to a projector using a VGA cable.

-  **NOTE:** The VGA option is available only with the VGA model of the device.
-  **NOTE:** The VGA cable will not ship with your device unless you ordered it.
-  **NOTE:** You need to install the **Viewer** program for the device to detect the projector. To configure the program, see the **Help** section in the program.

To connect the device to the projector, connect the sync connector on the VGA cable to the device, and then connect the other connector of the VGA cable to the projector cable. Run the Viewer program for the device to detect the projector.

## Checking Built-In Storage

The amount of on-board flash memory in your device is dependent on the device configuration and the operating-system image size. The memory is non-volatile, so the data saved here is not lost even if the device is totally out of power.

To check the available non-volatile memory space on your device:

- 1 Tap the **Start** button and tap **Settings**.
- 2 Tap the **System** tab and tap **Memory**.
- 3 Tap the **Storage Card** tab, and then select **Built-in Storage** from the drop-down menu to display the available space.

## Using Cards

### CompactFlash Cards

Your device supports CompactFlash Type II cards. Some common types of cards include:

- Modem — Connect a telephone line for modem data communications.
- Wireless communication — Perform data communications without the use of cable connections. You can use cards, such as internal cards with Bluetooth wireless technology and 802.11b wireless LAN.
- Storage — Save data or install programs on a storage card.

When you do not have a CompactFlash card installed, insert the plastic blank to protect the CompactFlash card slot.

To install a CompactFlash card:

- 1 If a blank is installed, remove it.

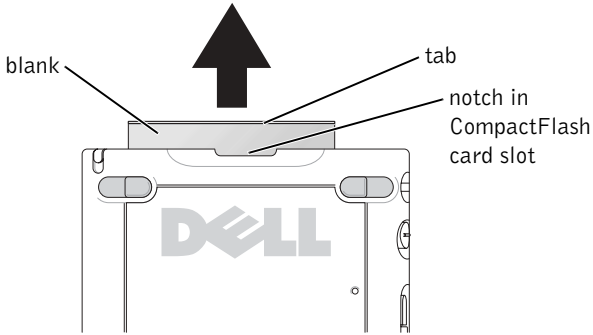

- 2 Align the tab on the back of the CompactFlash card with the notch in the CompactFlash card slot, and slide the card into the slot.

**NOTICE:** Do not force the card. If you feel resistance, remove the card, check the orientation, and reinsert it.

See the documentation that came with the card for information on using the card.

## Secure Digital Memory Cards

Use Secure Digital memory cards to save or back up data.

To install a Secure Digital memory card:

- 1 If a card is already installed, press in the card to release it, and then remove it.

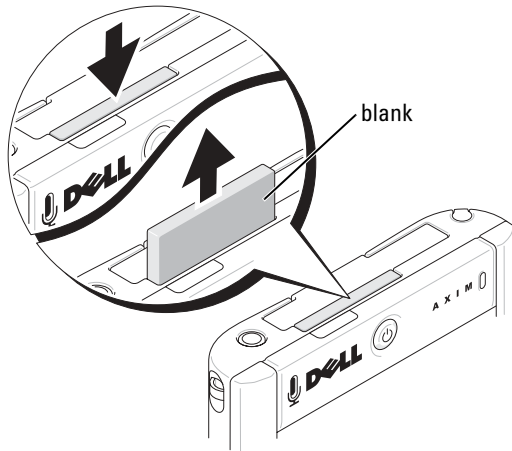

- 2 Ensure that the card is oriented correctly, and slide it into the slot until you feel a click.

**NOTICE:** Do not force the card. If you feel resistance, remove the card, check the orientation, and reinsert it.

See the documentation that came with the card for information on using the card.

## Performing a Reset

### Soft Reset

When you perform a soft reset, the device deletes any data that has not been saved but saves any data that has been stored in memory. Try performing a soft reset if the device does not respond when you tap the display or press a button.

To perform a soft reset, use the reset stylus to press the reset button.

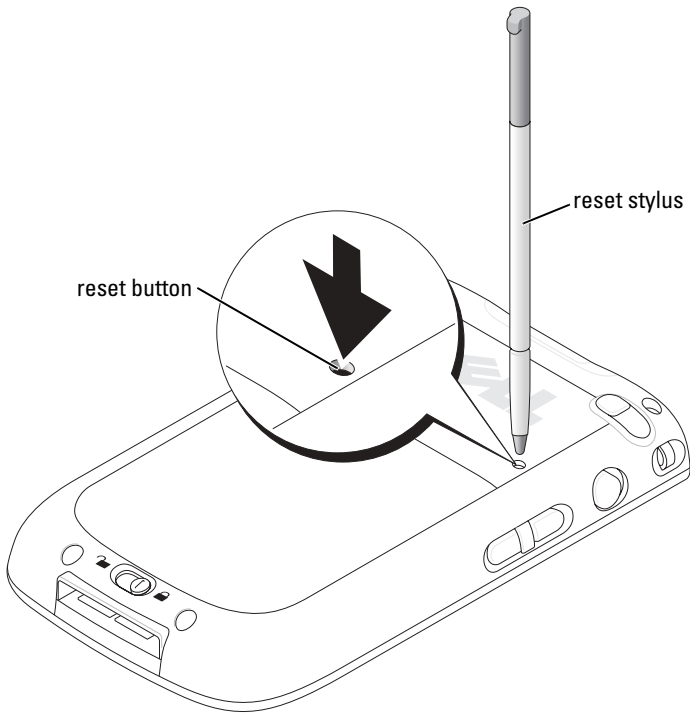



## Hard Reset



**NOTICE:** When you perform a hard reset, you lose all the data stored in your device memory, and any programs that you installed on your device.

Perform a hard reset if:

- You want to delete all the data stored in your device memory.
- You forget your password and need to clear it.
- Your device is experiencing severe operational problems and you have already attempted a soft reset.



**NOTICE:** It is strongly recommended that you back up your data before you perform a hard reset. See ActiveSync Help on your computer for more information.

To perform a hard reset:

- 1 Press and hold the power button.
- 2 Using the reset stylus, hold the reset button for about 2 seconds.
- 3 Follow the instructions on the screen.



# Using Microsoft® Windows Mobile™ 2003 Second Edition

## Device Buttons and the Reset Stylus

Your device has hardware buttons that control actions and scroll functions, and a stylus for selecting items and entering information.

On the device, the stylus replaces the mouse:

- Tap — Touch the screen once with the stylus to open items and select options.
- Drag — Hold the stylus and drag across the screen to select text and images. Drag in a list to select multiple items.
- Tap and hold — Tap and hold the stylus on an item to see a list of actions available for that item. On the pop-up menu that appears, tap the action you want to perform.

See "Entering Information" on page 43 for more information.

## Today Screen

When you turn on your device for the first time each day (or after 4 hours of inactivity), the **Today** screen appears. You can also view the **Today** screen by tapping the **Start** button and then tapping **Today**. The **Today** screen displays the date and information about the device owner, today's calendar, and important tasks. To customize the **Today** screen:



- 1 Tap the **Start** button and tap **Settings**.
- 2 Tap the **Personal** tab and tap **Today**.













Use the **Appearance** tab to change the background that displays on the **Today** screen.

Use the **Items** tab to change the items that appear on the **Today** screen.



## Status Icons

 **NOTE:** If there is not enough room to display all notification icons, the notification icon, , displays. Tap the notification icon to view all notifications.

Icon	Description
	Turns sound on and off.
	Backup battery is low.
	Main battery is charging.
	Main battery is low.
	Main battery is very low.
	Main battery is full.
	Connection is active. Tap the icon to configure connections.
	Connection is not detected.
	Wireless network is detected.
	Synchronization is beginning or ending.
	Synchronization is occurring.
	New instant message(s).
	New e-mail message(s).

## Programs

You can switch from one program to another by selecting a program from the **Start** menu. To access programs that are not listed in the **Start** menu, tap the **Start** button, tap **Programs**, and then tap the program name.



**NOTE:** Some programs have abbreviated labels for check boxes and drop-down menus. To see the full spelling of an abbreviated label, tap and hold the stylus on the label. Drag the stylus off the label so that the command is not carried out.

### Program Buttons

You can also switch to some programs by pressing a program button. Your device has four program buttons located on the front of the device. The icons on the buttons identify the programs to which they switch. By default, the buttons launch Home, Messaging, Contacts, and Calendar.

### Switcher Bar

You can also use Switcher Bar to switch to or close open programs. To launch Switcher Bar:











- 1 Tap the **Start** button and tap **Settings**.
- 2 Tap the **System** tab and tap **Switcher Bar**.

The Switcher Bar icon, , appears in the navigation bar.

Tap  to view a list of all open programs. In the **Switcher Bar** menu:

- Tap **Brightness settings** or **Power settings** to configure those settings.
- Tap a program name to switch to that program.
- Tap **Exit current program** to close the current program.
- Tap **Exit all programs** to close all open programs.
- Tap **Exit Switcher Bar** to close the menu.

The following table contains a partial list of programs that are on your device. See the *Dell™ Companion* CD for additional programs that you can install on your device.

<b>Icon</b>	<b>Program</b>	<b>Description</b>
	ActiveSync	Synchronize information between your device and your computer.
	Calendar	Keep track of your appointments and create meeting requests.
	Contacts	Keep track of your friends and colleagues.
	Messaging	Send and receive e-mail messages.
	Pocket Internet Explorer	Browse websites and WAP sites, and download new programs and files from the Internet.
	Notes	Create handwritten or typed notes, drawings, or recordings.
	Tasks	Keep track of your tasks.
	Pocket Excel	Create new workbooks or view and edit Excel workbooks that you created on your computer.
	MSN Messenger	Send and receive instant messages with your MSN Messenger contacts.
	Pocket Word	Create new documents or view and edit Word documents that you created on your computer.

## Navigation Bar and Command Bar

The navigation bar is located at the top of the screen. It displays the active program and current time and allows you to switch to other programs and close screens.

Use the command bar at the bottom of the screen to perform tasks in programs. The command bar includes menu names, icons, and the input panel icon. To create a new item in the current program, tap **New**. To see the name of an icon, tap and hold the stylus on the icon. Drag the stylus off the icon so that the command is not carried out.

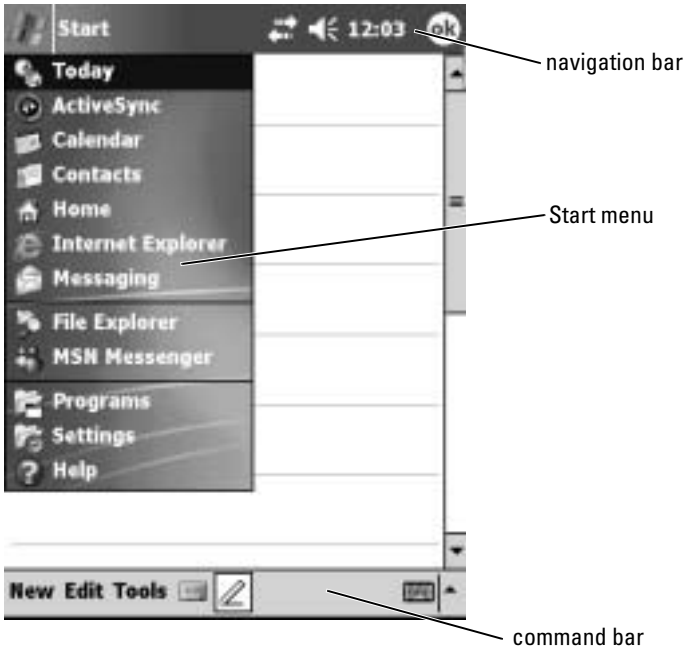



## Pop-Up Menus

With pop-up menus, you can quickly select an action for an item. For example, you can use the pop-up menu in the contact list to delete a contact, make a copy of a contact, or send an e-mail message to a contact. The actions in the pop-up menus vary from program to program. To access a pop-up menu, tap and hold the stylus on an item name. When the menu appears, lift the stylus and tap the action you want to perform. To close the menu without performing an action, tap anywhere outside the menu.

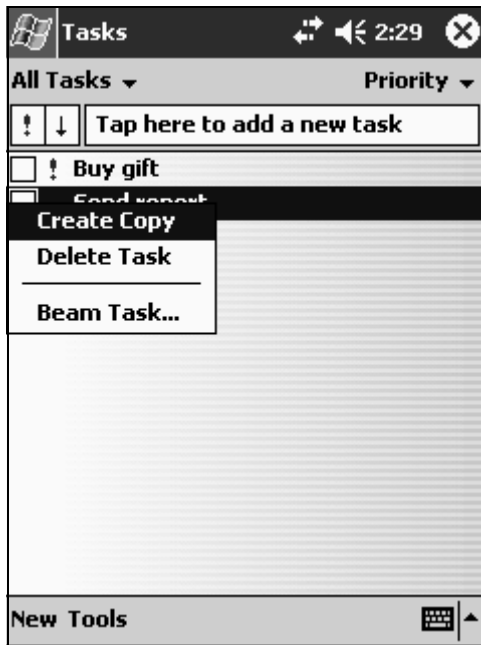

## Finding and Organizing Information

The Find feature on your device helps you to quickly locate information.

On the **Start** menu, tap **Find**. Enter the item that you want to find, select a data type from the drop-down menu, and then tap **Go** to start the search.

You can also use the File Explorer to find files on your device and to organize your files into folders. On the **Start** menu, tap **Programs** and tap **File Explorer**.

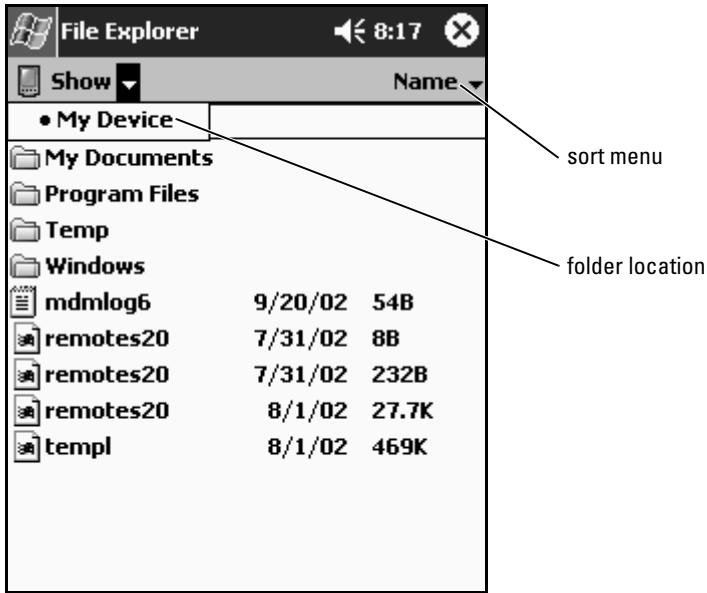

## Backing Up Data

To prevent or minimize data loss, you should periodically back up the data stored on your device. Use ActiveSync to synchronize the files on your device with the files on your computer. You can also drag and drop files from your device to your computer using Windows Explorer. See the ActiveSync Help on your computer for additional information.

## Entering Information

You have several options for entering information:

- Use the input panel to enter typed text using the soft keyboard or another input method.
- Write directly on the screen with the stylus.
- Draw pictures on the screen with the stylus.
- Speak into your device microphone to record a message.

Use Microsoft® ActiveSync® to synchronize or copy information from your computer to your device. For more information on ActiveSync, see ActiveSync Help on your computer.

### Entering Text Using the Input Panel

Use the input panel to enter information in any program on your device. You can type using the soft keyboard or write using Letter Recognizer, Block Recognizer, or Transcriber. The characters appear as typed text on the screen.

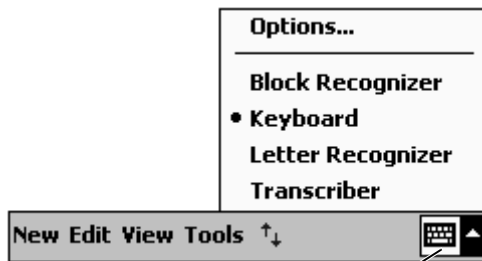

input panel icon

To show or hide the input panel, tap the input panel icon. Tap the arrow next to the input panel icon to change input methods.

When you use the input panel, your device anticipates the word you are typing or writing and displays it above the input panel. When you tap the displayed word, the word is inserted at the insertion point. The more you use your device, the more words it learns to anticipate.

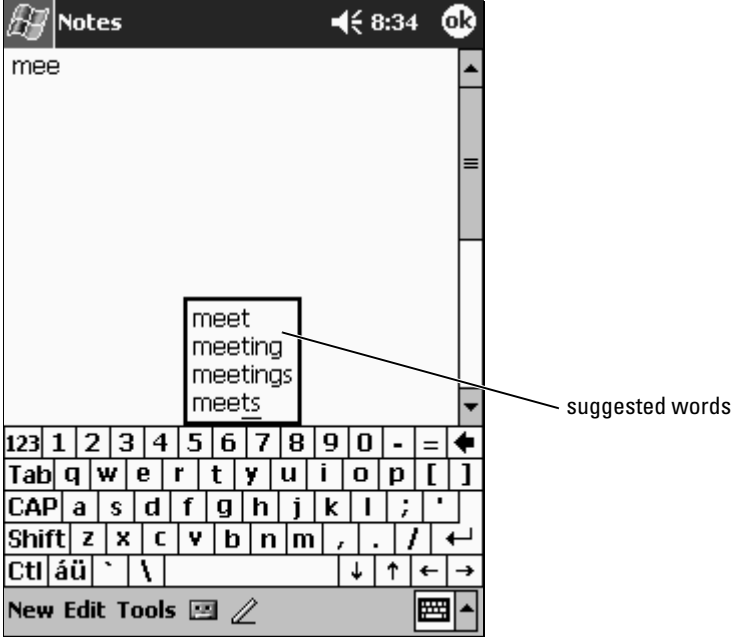

To change word suggestion options, such as the number of words suggested:

- 1 Tap the **Start** button and tap **Settings**.
- 2 Tap the **Personal** tab, tap **Input**, and then tap the **Word Completion** tab.
- 3 Select the desired settings and tap **OK**.

## Typing With the Soft Keyboard

- 1 Tap the arrow next to the input panel icon and tap **Keyboard**.
- 2 Tap the keys on the soft keyboard with your stylus.

## Letter Recognizer

Letter Recognizer allows you to use your stylus to write letters on the screen as you would write them on paper.



**NOTE:** Letter Recognizer is included with the English, French, German, Italian, and Spanish operating systems. Other versions do not support Letter Recognizer.

- 1 Tap the arrow next to the input panel icon and tap **Letter Recognizer**.
- 2 With your stylus, write a letter between the lines that appear on the bottom of the screen.

The letters are converted to typed text on the screen. For specific instructions on using Letter Recognizer, tap the question mark next to the writing area.



**NOTE:** Tap **Demo** to learn the character strokes that the device can recognize.

## Block Recognizer

Block Recognizer allows you to use character strokes that are similar to those used on other handheld devices.



**NOTE:** Block Recognizer is included with the English, French, German, Italian, and Spanish operating systems. Other versions do not support Block Recognizer.

- 1 Tap the arrow next to the input panel icon and tap **Block Recognizer**.
- 2 Using your stylus, write the appropriate character stroke in the box that appears at the bottom of the screen.

The character strokes are converted to typed text on the screen. For specific instructions on using Block Recognizer, tap the question mark next to the writing area.



**NOTE:** Tap **Demo** to learn the character strokes that the device can recognize.

## Transcriber

Transcriber allows you to write anywhere on the screen using the stylus similar to the way that you would write on paper. Unlike Letter Recognizer and Block Recognizer, you can write a sentence or more, and then pause to let Transcriber change the written characters to typed characters.



**NOTE:** Transcriber is included with the English, French, and German operating systems. Other versions do not support Transcriber.

- 1 Tap the arrow next to the input panel icon and tap **Transcriber**.
- 2 With your stylus, write anywhere on the screen.

When you pause, Transcriber converts your written characters to typed characters. For specific instructions on using Transcriber, tap the question mark in the lower right hand corner of the screen.

## Editing Typed Text

To edit or format typed text, you must select it first:

- 1 Drag the stylus across the text that you want to select.
- 2 Tap and hold the selected text.
- 3 Tap the appropriate editing command in the pop-up menu.

You can also tap **Edit** at the bottom of the screen to select editing commands.

## Writing on the Screen

In any program that accepts written text, such as the Notes program and the **Notes** tab in some programs, you can use your stylus to write directly on the screen. You can edit and format what you have written and convert the information to text at a later time.



**NOTE:** Some programs that accept written text may not have the pen icon. See the documentation for that program to find out how to switch to writing mode.

To write on the screen, tap the pen icon to switch to writing mode. This action displays lines on the screen to help you write.



## Editing Written Text

To edit or format written text, you must select it first:

- 1 Tap the pen icon to deselect it.
- 2 Drag the stylus across the text that you want to select.
- 3 Tap and hold the selected text.
- 4 Tap the appropriate editing command in the pop-up menu.  
You can also tap **Edit** at the bottom of the screen to select editing commands.
- 5 Tap the pen icon to switch back to writing mode.

To convert written text to print-style text, tap **Tools** and tap **Recognize**.

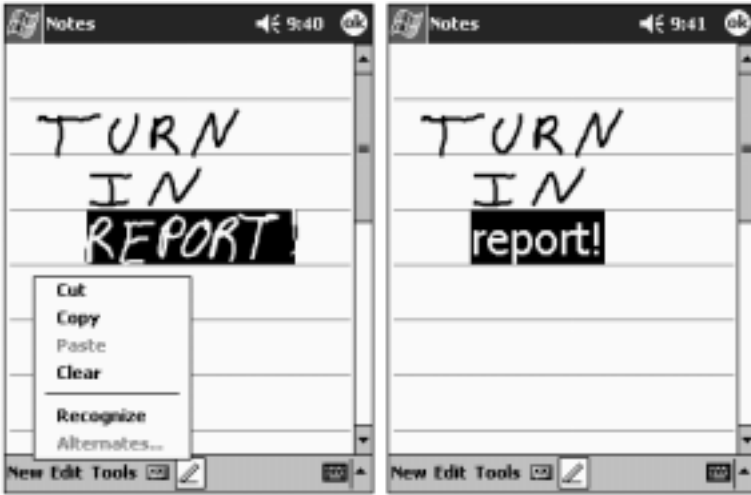

If you want to convert only certain words, select them before tapping **Recognize** (or tap and hold the selected words and then tap **Recognize** on the pop-up menu). If a word is not recognized, it is not converted to print-style text.

If the conversion is incorrect, you can select different words from a list of alternatives or return to the original written text:

- 1 Tap and hold the incorrect word.
- 2 On the pop-up menu, tap **Alternates**.  
A menu with a list of alternative words appears.
- 3 Tap the correct word, or tap the written text at the top of the menu to return to the original written text.



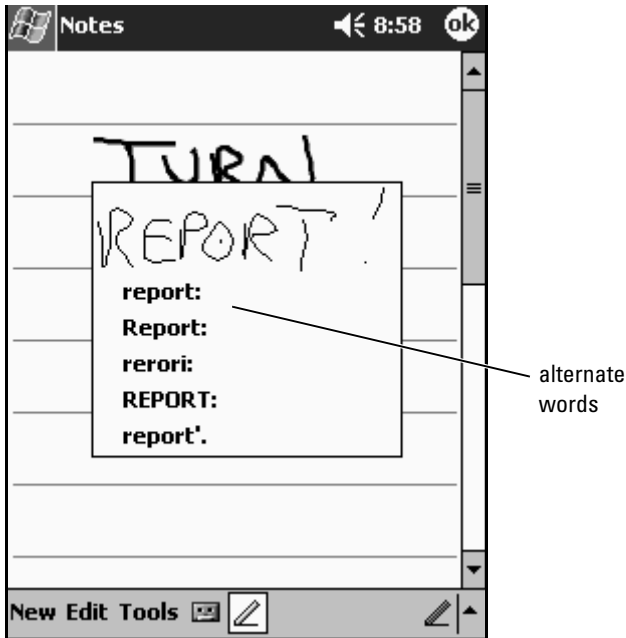

Tips for getting good recognition:

- Write neatly.
- Write on the lines and draw descenders below the line. Write the cross of the "t" and apostrophes below the top line so that they are not confused with the word above. Write periods and commas above the line.
- For better recognition, try changing the zoom level to 300 percent using the **Tools** menu.
- Write the letters of a word closely and leave big gaps between words so that the device can easily determine where words begin and end.
- Hyphenated words, foreign words that use special characters such as accents, and some punctuation cannot be converted.
- You cannot add written text to a word to change it after the word has been recognized. You must delete the written word and write the new word.

## Drawing on the Screen

You can draw on the screen the same way that you write on the screen; however, selecting and editing drawings is different than selecting and editing written text. For example, selected drawings can be resized, while written text cannot.

### Creating a Drawing

 **NOTE:** To zoom in or out on your drawing, tap **Tools** and tap a zoom level.

Cross three ruled lines on your first stroke. A drawing box appears. Subsequent strokes that touch or are inside of the drawing box become part of the drawing. Drawings that do not cross three ruled lines are treated as written text.

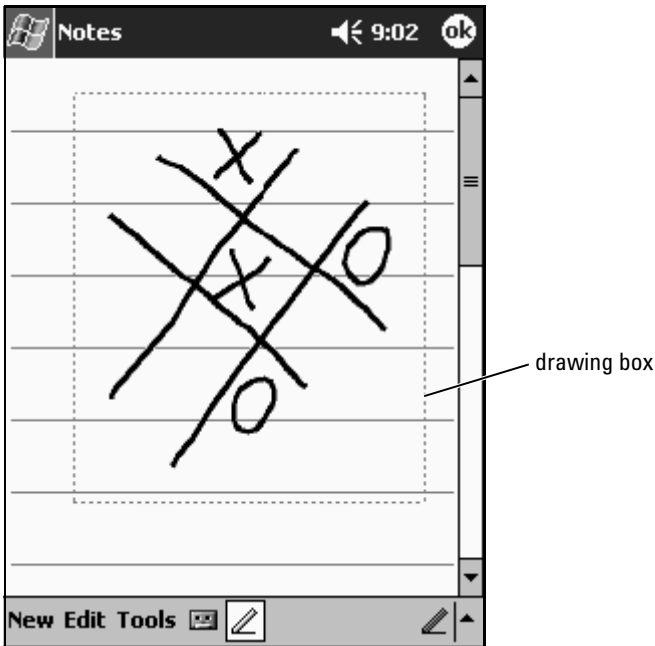

## Editing a Drawing

To edit or format a drawing, you must select it first:

- 1 Tap and hold the stylus on the drawing until the selection handle appears. To select multiple drawings, deselect the pen icon and drag to select the drawings.
- 2 Tap and hold the selected drawing and tap an editing command on the pop-up menu.
- 3 You can cut, copy, and paste selected drawings by tapping and holding the selected drawing and then tapping an editing command on the pop-up menu.

You can also tap **Edit** at the bottom of the screen to select editing commands.

To resize a drawing, ensure that the Pen icon is not selected, and drag a selection handle.

## Recording a Message

In any program where you can write or draw on the screen, you can also quickly capture thoughts, reminders, and phone numbers by recording a message. In Calendar, Tasks, and Contacts, you can include a recording in the **Notes** tab. In the Notes program, you can either create a stand-alone recording or include a recording in a written note. If you want to include the recording in a note, open the note first. In the Messaging program, you can add a recording to an e-mail message.

To record a message:

- 1 Hold the microphone near your mouth or other source of sound.
- 2 Press and hold the Record button on the side of your device until it beeps.
- 3 While holding down the Record button, make your recording.
- 4 To stop recording, release the Record button.

The device beeps twice. The new recording appears in the note list or as an embedded icon.



**NOTE:** You can also make a recording by tapping the Record icon on the Recording toolbar.

To play a recording, tap the name of the recording in the list or tap the speaker icon in the note.

## Using My Text

When using Messaging or MSN Messenger, use My Text to quickly insert preset or frequently used messages. To insert a message, tap **My Text** and tap a message.



**NOTE:** You can add text to a My Text message after you insert the message.

To edit a My Text message:

- 1 In Messaging or MSN Messenger, tap **Tools**.
- 2 Tap **Edit My Text Messages**.
- 3 Make the changes and tap **OK**.

# Adjusting Settings

You can adjust the device settings to suit the way you work. To see available options, tap the **Start** button and tap **Settings**.

 **NOTE:** Depending on the features of your device, you might have additional tabs and additional items on the tabs.

See Pocket PC Help on your device for additional information on adjusting settings (tap the **Start** button and tap **Help**).

## Personal Tab

- **Buttons** — Assign the programs that launch when you press the hardware buttons.
- **Input** — Adjust the settings for input method, word completion, and other options.
- **Menus** — Add or remove items from the **Start** menu.
- **Owner Information** — Enter your contact information.
- **Password** — Set a password to protect the data stored on your device.
- **Sounds & Notification** — Adjust the volume and set notifications. See "Notifications" on page 69 for more information.
- **Today** — Customize the look and the information that is displayed on the Today screen.

## System Tab

- **About** — Find information about Microsoft® Windows Mobile™ 2003 Second Edition and your device.
- **Brightness** — Adjust the brightness settings to conserve power.
- **Certificates** — View or delete certificates stored on your device. Certificates help establish your identity and the identity of other computers to prevent unauthorized users from accessing your data.
- **Clock & Alarms** — Change the time or set the alarm.

- **Memory** — Allocate memory for data and program storage. View free and used memory, storage card memory, and running programs.
- **Microphone** — Adjust the microphone gain.
- **Power** — Check the battery or charge status. Set the amount of time that the device can remain idle before it turns off on the **Advanced** tab.
- **Regional Settings** — View and change the formatting for regional settings, such as currency, time, and date.
- **Remove Programs** — Remove programs from your device. For more information, see "Adding and Removing Programs" on page 71.
- **Screen** — Adjust the screen if your device is not responding accurately to taps, and select the screen orientation that you want to use.
- **Switcher Bar** — Adjust the settings of the Switcher Bar program launcher utility.
- **System Information** — View technical information about your device.

## Connections Tab

- **Beam** — Receive infrared beams from other devices.
- **Bluetooth** — Turn on the radio with Bluetooth® wireless technology and off, and create and edit bonded devices. By default, the radio is off.
- **Connections** — Add and configure modem or server connections.
- **Dell WLAN Utility** — Available only on devices with Wi-Fi.
- **Network Cards** — Configure your network adapter settings.

# Using the Microsoft<sup>®</sup> ActiveSync<sup>®</sup> Program

## About ActiveSync

You can synchronize the information on your computer with the information on your device with ActiveSync. Synchronization compares the data on your device with the data on your computer and updates both with the most recent information. For example:

- Keep Microsoft Pocket Outlook data up-to-date by synchronizing your device with Microsoft Outlook data on your computer.
- Synchronize Microsoft Word and Microsoft Excel files between your device and your computer. Your files are automatically converted to the correct format.



**NOTE:** By default, ActiveSync does not automatically synchronize all types of information. You can change ActiveSync options to synchronize specific types of information.

With ActiveSync, you can also:

- Back up and restore your device data.
- Copy (rather than synchronize) files between your device and your computer.
- Select a synchronization mode to control when synchronization occurs. For example, you can synchronize continuously or only when you select the synchronize command.
- Select which information types are synchronized and control how much data is synchronized. For example, you can choose how many weeks of past appointments you want synchronized.

To synchronize your data, you need both the Microsoft Windows<sup>®</sup> and Pocket PC versions of ActiveSync. You must install the Windows version of ActiveSync on your computer using the *Dell™ Companion* CD. The Pocket PC version is already installed on your device.



**NOTE:** Before connecting your device to a computer for the first time, ensure that you install ActiveSync on the computer using the *Dell™ Companion* CD.

## Installing and Using ActiveSync

To install ActiveSync:

- 1 Insert the *Dell Companion* CD.
- 2 Click **Getting Started** to access the main menu.
- 3 Click **Start Here**.
- 4 Click **Install ActiveSync** and follow the instructions on the screen.

After the installation is complete, the ActiveSync Setup Wizard helps you to connect your device to your computer, set up a partnership so that you can synchronize information between your device and your computer, and customize your synchronization settings. Your first synchronization process automatically begins when you complete the wizard.



**NOTE:** The device must be powered on for the synchronization process to occur.

During your first synchronization, information that was stored in Outlook on your computer is copied to Calendar, Contacts, and Tasks on your device.

After you set up ActiveSync and complete the first synchronization process, you can initiate synchronization from your device. To switch to ActiveSync on your device, tap the **Start** button and tap **ActiveSync**. If you have a wireless LAN card, you can synchronize remotely from your device.

To find information on using ActiveSync on your device, open ActiveSync on your device, tap the **Start** button, and then tap **Help**.

To find information on using ActiveSync on your computer, open ActiveSync on your computer, and click **Help**→**Microsoft ActiveSync Help**.



# Scheduling and Communicating

## About Microsoft® Pocket Outlook

Pocket Outlook includes Calendar, Contacts, Tasks, Messaging, and Notes. You can use these programs individually or together. For example, e-mail addresses stored in Contacts can be used to address e-mail messages in Messaging.

Using Microsoft ActiveSync®, you can synchronize information in Microsoft Outlook or Microsoft Exchange on your computer with your device. You can also synchronize this information directly with an Exchange server. Each time you synchronize, ActiveSync compares the changes you made on your device and computer or server and updates both computers with the latest information. For information on using ActiveSync, see ActiveSync Help on your computer.

You can switch to any of the following programs through the **Start** menu.

## Calendar

Use Calendar to schedule appointments, including meetings and other events. You can check your appointments in one of several views (Agenda, Day, Week, Month, and Year) and easily switch views by using the view menu. Tap the today icon to view the current date.

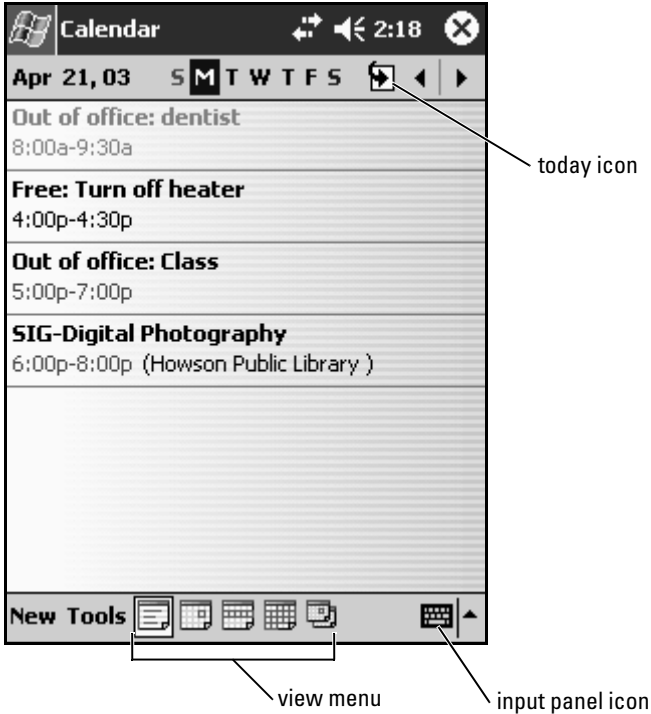

 **NOTE:** To customize Calendar, such as changing the first day of the week, tap **Tools** and tap **Options**.

To create an appointment:

- 1 In the Day or Week view, tap the desired date and time for the appointment.
- 2 Tap **New**.
- 3 Tap a field to select it, and enter a description and a location using the input panel.
- 4 If necessary, tap the date and time to change them.
- 5 To see all available fields, tap the input panel icon to hide it. Enter the remaining information, if necessary.

- 6 To add notes, tap the **Notes** tab.

You can enter text, draw, or create a recording. For more information on creating notes, see "Notes" on page 63.

- 7 When you have finished entering information, tap **OK** to return to the calendar.

To receive a notification for an appointment, select **Remind me** in the appointment settings. You can configure notifications through the Sounds & Notifications icon. For more information, see "Notifications" on page 69.

## Using the Summary Screen

When you tap an appointment in Calendar, a summary screen displays. To change the appointment, tap **Edit**.

## Creating Meeting Requests

You can use Calendar to set up meetings with users of Outlook or Pocket Outlook. The meeting request is automatically created when you synchronize Messaging or when you connect to your e-mail server. To set how you want meeting requests sent, tap **Tools** and tap **Options**. If you send and receive e-mail messages through ActiveSync, select **ActiveSync**.

To schedule a meeting:

- 1 Create an appointment.
- 2 On the **Appointment** tab, tap the input panel to hide it, and then tap **Attendees**.

The **Attendees** field lists the e-mail addresses that you have entered in Contacts.

- 3 Select the meeting attendees.

The meeting notice is created automatically and placed in the **Outbox** folder.

For more information on sending and receiving meeting requests, tap the **Start** button, tap **Help**, and then tap **Calendar** or **Messaging**.

## Contacts

Use Contacts to maintain a list of your friends and colleagues. You can quickly share Contacts information with other device users using the infrared port.

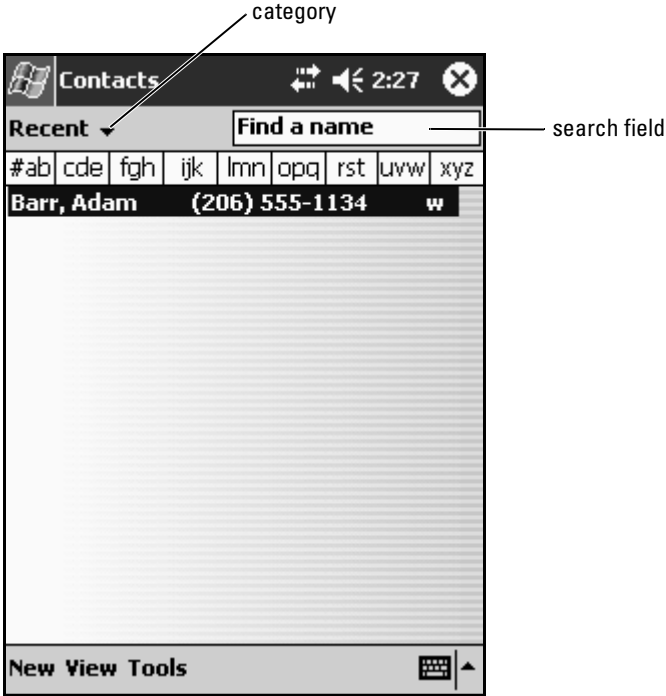

 **NOTE:** To change the way information is displayed in the list, tap **Tools** and tap **Options**.

To create a contact:

- 1 Tap the **Start** button and tap **Contacts**.
- 2 Tap **New**.
- 3 Using the input panel, enter a name and other contact information. Scroll down to see all available fields.

- 4 To assign the contact to a category, tap **Categories** and select a category from the list.  
In the contact list, you can display contacts by category.
- 5 To add notes, tap the **Notes** tab. You can enter text, draw, or create a recording. For more information on creating notes, see "Notes" on page 63.
- 6 When you have finished entering information, tap **OK** to return to the calendar.

## Finding a Contact

You can find a contact using one of the following methods:

- In **Contacts**, enter a contact name in the field under the navigation bar. To show all contacts, clear text from the box or tap the arrow to the right of the box.
- In **Contacts**, tap the category list (labeled **All Contacts** by default) and select a category. To show all contacts again, tap **All Contacts**. To view a contact not assigned to a category, select **None**.
- To view the names of companies your contacts work for, tap **View** in the contact list and tap **By Company**. The number of contacts that work for that company is displayed to the right of the company name.
- Tap the **Start** button, tap **Find**, and then enter the contact name. In the **Type** drop-down menu, tap **Contacts**, and then tap **Go**.

## Using the Summary Screen

When you tap a contact in the contact list, a summary screen is displayed. To change the contact information, tap **Edit**.

## Tasks



**NOTE:** To change the way information is displayed in the list, tap **Tools** and tap **Options**.

Use **Tasks** to keep a list of things that you need to do.



sort menu

To create a task:

- 1 Tap the **Start** button and tap **Tasks**.
- 2 Tap **New**.
- 3 Enter a description using the input panel.
- 4 If necessary, enter a start date and due date or other information by first tapping the field. Tap the input panel icon to hide it to see all available fields.
- 5 To assign the task to a category, tap **Categories** and select a category from the list. In the task list, you can display tasks by category.
- 6 To add notes, tap the **Notes** tab. You can enter text, draw, or create a recording. For more information on creating notes, see "Notes" on page 63.
- 7 When you have finished entering information, tap **OK** to return to the calendar.



**NOTE:** To quickly create a task with only a subject, tap **Tools** and tap **Entry Bar**. Tap **Tap here to add a new task**, and enter your task information.

## Notes

Quickly capture thoughts, reminders, ideas, drawings, and phone numbers with Notes. You can create a written note or a recording. You can also include a recording in a note. If a note is open when you create the recording, it is included in the note as an icon. If a note is not open, the recording is saved as a stand-alone recording.

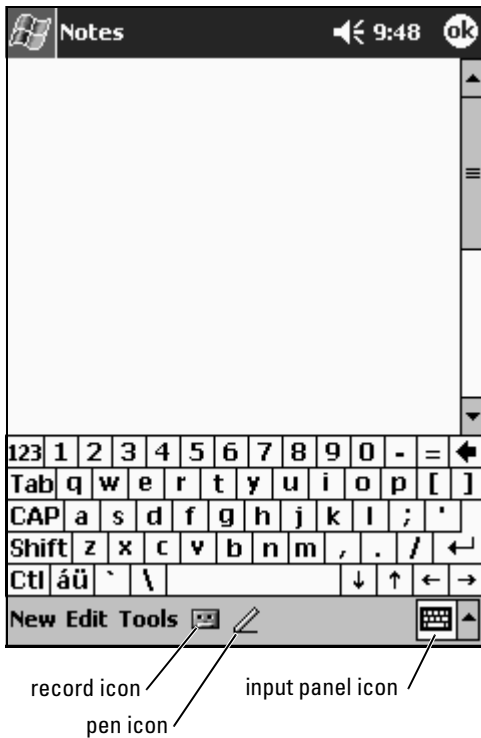

To create a note:

- 1 Tap the Start menu, tap Programs, and then tap Notes.
- 2 Tap New.
- 3 Create your note by writing, drawing, typing, or recording. For more information on using the input panel, writing and drawing on the screen, and creating recordings, see "Entering Information" on page 43.

# Messaging

Use Messaging to send and receive e-mail messages:

- Synchronize e-mail messages using Exchange or Outlook on your computer.
- Send and receive e-mail messages by connecting directly to an e-mail server through an ISP or a network.

## Synchronizing E-Mail Messages

You can synchronize e-mail messages along with the rest of your data if you enable Messaging synchronization in ActiveSync. For information on enabling Messaging synchronization, see ActiveSync Help on your computer.



**NOTE:** You can also synchronize e-mail messages with your computer from a remote location. For more information, see "Getting Connected" on page 91.

During synchronization:

- Messages are copied from the e-mail folders of Exchange or Outlook on your computer to the **ActiveSync** folder in Messaging on your device. By default, you receive:
  - Messages from the past 3 days
  - The first 100 lines of each message
  - File attachments of less than 100 KB in size
- E-mail messages in the **Outbox** folder on your device are transferred to Exchange or Outlook on your computer, and then sent from those programs.
- E-mail messages in subfolders on your computer must be selected in ActiveSync to be transferred.

## Connecting Directly to an E-Mail Server

In addition to synchronizing e-mail messages with your computer, you can send and receive e-mail messages by connecting to an e-mail server using a modem or network card connected to your device. You need to set up a remote connection to a network or an ISP, and a connection to your e-mail server. For more information, see "Getting Connected" on page 91.



When you connect to the e-mail server:

- New messages are downloaded to the device **Inbox** folder.
- Messages in the device **Outbox** folder are sent.
- Messages that have been deleted on the e-mail server are removed from the device **Inbox** folder.

Messages that you receive directly from an e-mail server are linked to your e-mail server rather than to your computer. When you delete a message on your device, it is also deleted from the e-mail server the next time you connect depending on the settings you selected in ActiveSync.

When you are working online, you read and respond to messages while connected to the e-mail server. Messages are sent as soon as you tap **Send**, which saves space on your device.

After you have downloaded new message headers or partial messages, you can disconnect from the e-mail server and then decide which messages to download completely. The next time you connect, Messaging downloads the messages you have marked for retrieval and sends the messages you have composed.

## **Using the Message List**

Messages you receive are displayed in the message list. By default, the most recently received messages are displayed first in the list.

When you receive a message, tap to open it. Unread messages are displayed in bold.

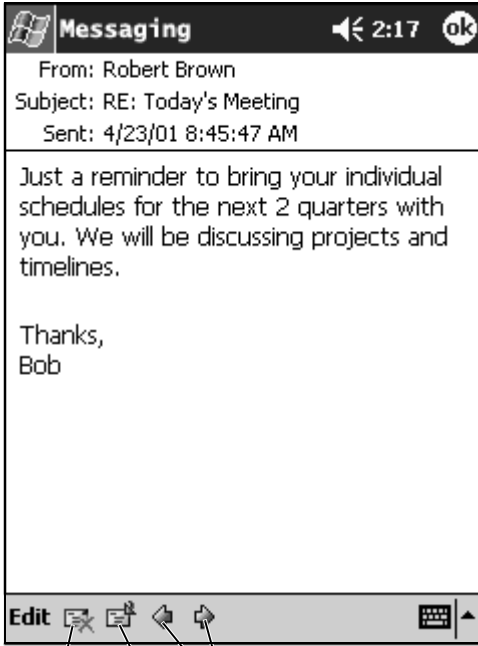

delete icon      previous/next message  
forward icon

When you connect to your e-mail server or synchronize with your computer, you receive by default:

- Messages from the last 5 days
- The first 100 lines of each new message
- File attachments of less than 100 KB in size

The original messages remain on the e-mail server or your computer. You can mark the messages that you want to retrieve in full during your next synchronization or e-mail server connection. In the message list, tap and hold the message that you want to retrieve. On the pop-up menu, tap **Mark for Download**. The icons in the Inbox message list indicate message status.

You specify your downloading preferences when you set up the service or select your synchronization options. You can change the settings at any time:

- Change options for Messaging synchronization using ActiveSync options. For more information, see ActiveSync Help on your computer.
- Change options for direct e-mail server connections in Messaging on your device. Tap **Tools** and tap **Options**. On the **Account** tab, tap the service that you want to change. Tap and hold the service and select **Delete** to remove a service.

## Composing Messages

To compose a message:

- 1 Tap the **Start** button and tap **Messaging**.
- 2 Tap **New**.

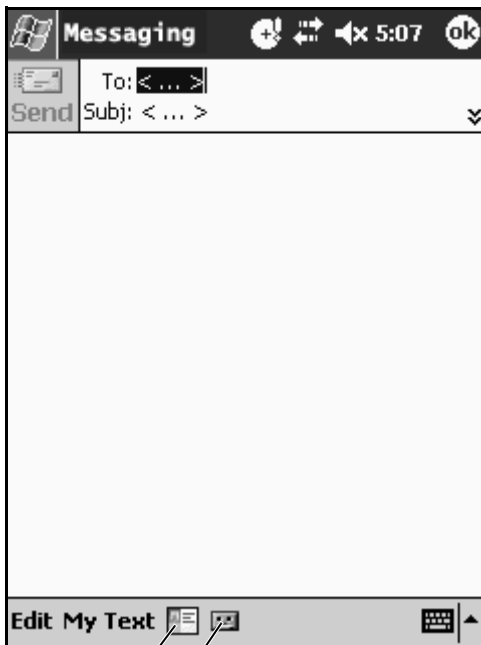

Contacts icon

record icon

- 3 In the **To** field, enter an e-mail of one or more recipients, separating them with a semicolon. Or tap the **Contacts** icon to select names from the contact list.



**NOTE:** All e-mail addresses entered in the e-mail fields in **Contacts** appear in the **Address Book**.

- 4 Compose your message. To enter preset or frequently used messages, tap **My Text** and select a message.

- 5 Tap **Send** when you have finished the message.

If you are working offline, the message is moved to the **Outbox** folder and sent the next time you connect.

## Managing E-Mail Messages and Folders

By default, messages are displayed in one of five folders for each service you have created: **Inbox**, **Deleted Items**, **Drafts**, **Outbox**, or **Sent Items**. The **Deleted Items** folder contains messages that have been deleted on the device. The behavior of the **Deleted Items** and **Sent Items** folders depends on the options you have selected. To change the options, tap **Tools** in the message list and tap **Options**. On the **Message** tab, select your options.

To create a new folder, tap **Tools**, and tap **Manage Folders**. To move a message to another folder, tap and hold the message in the message list and tap **Move to** on the pop-up menu.

### Folder Behavior With a Direct Connection to an E-Mail Server

The behavior of the folders you create depends on whether you use **ActiveSync**, **POP3**, or **IMAP4**.

- *If you use **ActiveSync***, e-mail messages in the **Inbox** folder in **Outlook** are automatically synchronized with your device. You can select to synchronize additional folders by designating them for **ActiveSync**. The folders you create and the messages you move are then mirrored on the server. For example, if you move messages from the **Inbox** folder to a folder named **Family**, and you have designated **Family** for synchronization, the server creates a copy of the **Family** folder and copies the messages into that folder. You can then read the messages while away from your computer.

- *If you use POP3 and you move e-mail messages to a folder you created, the link is broken between the messages on the device and their copies on the e-mail server. The next time you connect, the e-mail server detects that the messages are missing from the device Inbox and deletes them from the server. This prevents you from having duplicate copies of a message. However, you no longer have access to messages that you move to folders created from anywhere except the device.*
- *If you use IMAP4, the folders you create and the e-mail messages you move are mirrored on the server. Therefore, messages are available to you any time you connect to your e-mail server, whether it is from your device or computer. This synchronization of folders occurs whenever you connect to the server, create new folders, or rename/delete folders when connected.*

## Notifications

You can set your device to remind you when you have something to do. For example, if you have set up an appointment in Calendar, a task with a due date in Tasks, or an alarm in Clock, you are notified in one of the following ways:

- A message box appears on the screen.
- A sound, which you can specify, is played.
- A light flashes on your device.

To configure the reminders and sounds for your device:

- 1 Tap the **Start** button and tap **Settings**.
- 2 On the **Personal** tab, tap **Sounds & Notifications**.
  - **Sounds** tab — Adjust the volume and enable sounds.
  - **Notifications** tab — Set notifications for specific events.



## Adding and Removing Programs

Programs that were already installed when you received your device are stored in ROM. You cannot remove these programs, and you never accidentally lose ROM contents. ROM programs can be updated using installation programs with the \*.xip extension. You can save data to either ROM or RAM.

You can install any program created for your device as long as your device has sufficient memory. The most popular place to find software for your device is on the Microsoft® Windows Mobile™ 2003 Second Edition website: [www.microsoft.com/windowsmobile](http://www.microsoft.com/windowsmobile).

### Adding Programs Using Microsoft® ActiveSync®

You need to install the appropriate software for your device on your computer before installing software on your device. See "Using the Microsoft® ActiveSync® Program" on page 55 for more information.

- 1** Determine your device and processor type so that you know which version of the software to install:
  - a** Tap the **Start** button and tap **Settings**.
  - b** On the **System** tab, tap **About**.
  - c** From the **Version** tab, record the processor information.
- 2** Download the software to your computer (or insert the CD or floppy that contains the software into your computer). You may see a single \*.xip, \*.exe, or \*.zip file, a Setup.exe file, or several versions of files for different device types and processors. Ensure that you select the program designed for the Pocket PC and your device processor type.
- 3** Read any installation instructions, readme files, or documentation that comes with the program. Many programs provide special installation instructions.

- 4 Connect your device to your computer.
- 5 Double-click the \*.exe file.

If the file is an installer file, the installation wizard begins. Follow the directions on the screen. Once the software has been installed on your computer, the installer automatically transfers the software to your device.

If the file is not an installer file, you receive an error message stating that the program is valid but that it is designed for a different type of computer. You need to move this file to your device. If you cannot find any installation instructions for the program in the readme file or documentation, use ActiveSync Explore to copy the program file to the **Program Files** folder on your device. For more information on copying files using ActiveSync, see ActiveSync Help on your computer.

To open a program after the installation is complete, tap the **Start** button, tap **Programs**, and then tap the program icon.

## Downloading Programs From the Internet

- 1 Determine your device and processor type so that you know which version of the software to install:
  - a Tap the **Start** button and tap **Settings**.
  - b On the **System** tab, tap **About**.
  - c From the **Version** tab, record the processor information.
- 2 Using Pocket Internet Explorer, download the program to your device. You may see a single \*.xip, \*.exe or \*.zip file, a **Setup.exe** file, or several versions of files for different device types and processors. Ensure that you select the program designed for the Pocket PC and your device processor type.
- 3 Read any installation instructions, readme files, or documentation that comes with the program. Many programs provide special installation instructions.
- 4 Tap the file, such as a \*.xip or \*.exe file.

The installation wizard begins. Follow the directions on the screen.



## Adding a Program to the Start Menu

- 1 Tap the **Start** button and tap **Settings**.
- 2 Tap **Menus**, tap the **Start Menu** tab, and then tap the check box for the program.

If the program is not listed, you can either use File Explorer on the device to move the program to the **Start Menu** folder, or use ActiveSync on the computer to create a shortcut to the program and place the shortcut in the **Start Menu** folder.

### Using File Explorer on the Device

- 1 Tap the **Start** button, tap **Programs**, and tap **File Explorer**.
- 2 Locate the program. Tap the folder list (labeled **My Documents** by default) and then tap **My Device** to see a list of all folders on the device.
- 3 Tap and hold the program name and tap **Cut** on the pop-up menu.
- 4 Open the **Start Menu** folder located in the **Windows<sup>®</sup>** folder.
- 5 Tap and hold a blank area of the window, and tap **Paste** on the pop-up menu.

The program now appears on the **Start** menu. For more information on using File Explorer, see "Finding and Organizing Information" on page 41.

### Using ActiveSync on the Computer

Use Explorer in ActiveSync to explore your device files and locate the program. Right-click the program and click **Create Shortcut**. Move the shortcut to the **Start Menu** folder in the **Windows** folder. The shortcut now appears on the **Start** menu. For more information, see ActiveSync Help on your computer.

## Error Message When Installing Software

When installing software on your device, you may receive the following error message:

The program you have installed may not display properly because it was designed for a previous version of Microsoft® Windows Mobile™ software.

To correct the error:

- 1 Tap **ok** to continue installing the software program.
- 2 Run the program in portrait mode. See "Changing the Display Mode on Your Device" on page 74.



**NOTE:** Most device programs function with the Windows Mobile 2003 Second Edition operating system when using portrait mode. Dell cannot guarantee proper functioning of a program that was not written for Windows Mobile 2003 Second Edition.



**NOTE:** The Dell Axim X50 has the Windows Mobile 2003 Second Edition operating system installed. Most device software packages currently available were designed for previous versions of Windows Mobile. If you need technical assistance with the software you are trying to install, contact the manufacturer of the software. Dell does not provide support for third-party electronics and accessories.

For more information on the Dell™ Electronics and Accessories Technical Support Policy, search for Dell Knowledge Base article RA1062902 at [support.dell.com](http://support.dell.com).

## Changing the Display Mode on Your Device

To change the display mode from landscape to portrait:

- 1 Tap the **Start** button and tap **Settings**.
- 2 In the **Settings** window, tap the **System** tab and tap **Screen**.
- 3 In the **Screen** window, tap **Portrait** to select portrait mode.
- 4 Tap **ok** and close the window.



**NOTE:** To change the display mode from portrait to landscape, follow the steps in reverse order.

## File Download Security Warning

The following File Download Security Warning message appears when attempting to install software programs onto your Dell system running Microsoft® Window® XP Service Pack 2 (SP2).



As a safety precaution, the File Download Security Warning appears whenever you attempt to install a software program onto your system. This occurs regardless of who makes the software you are attempting to install.

 **NOTE:** This warning is not indicative of a problem with your Dell system.

## Removing Programs

- 1 Tap the **Start** button and tap **Settings**.
- 2 Tap the **System** tab and tap **Remove Programs**.  
If the program does not appear in the list of installed programs, use File Explorer on your device to locate the program.
- 3 Tap and hold the name of the program, and tap **Delete** in the pop-up menu.



# Using Companion Programs

The companion programs include Microsoft Pocket Word, Microsoft Pocket Excel, Microsoft Money, Windows Media Player for Pocket PC, and Microsoft Reader.

To switch to a companion program on your device, tap the **Start** button, tap **Programs**, and then tap the program name.

## Microsoft<sup>®</sup> Pocket Word

Pocket Word works with Microsoft Word on your computer to give you easy access to copies of your documents. You can create new documents on your device, or you can copy documents from your computer to your device. Synchronize documents between your computer and your device so that you have the most up-to-date content in both locations.

Use Pocket Word to create documents, such as letters, meeting minutes, and travel reports. To create a new file:

- 1 Tap the **Start** button → **Programs** → **Pocket Word**.
- 2 Tap **New**.

A blank document appears. Or, if you selected a template for new documents in the **Options** dialog box, the template appears with appropriate text and formatting already provided.

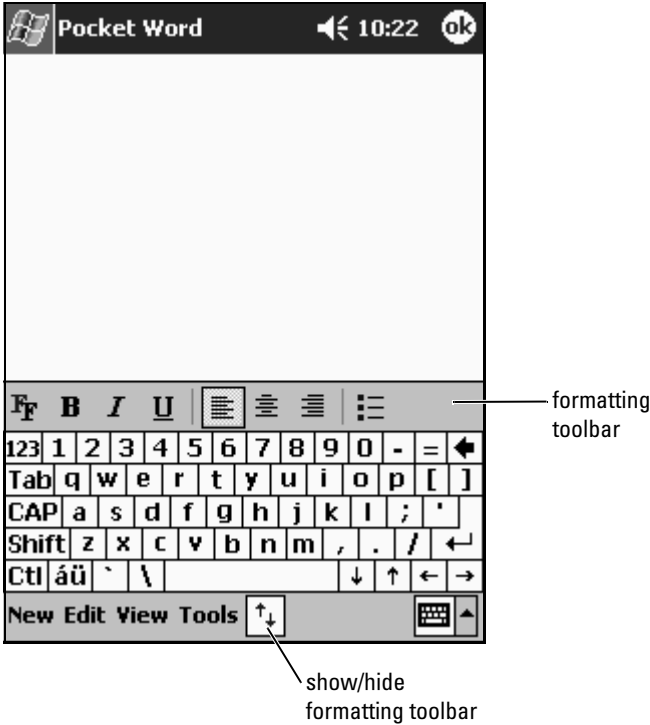

You can open only one document at a time. If you open a second document, you are asked to save the first one. You can create, save, or edit a document in a variety of formats, including Word (.doc), Pocket Word (.psw), Rich Text Format (.rtf), and Plain Text (.txt).

Pocket Word contains a list of the files stored on your device. Tap a file in the list to open it. To delete, make copies of, or send files, tap and hold a file in the list. Then select the appropriate action in the pop-up menu.

You can enter information in Pocket Word in one of four modes: typing, writing, drawing, or recording. These modes are displayed on the **View** menu. Each mode has its own toolbar, which you can show and hide by tapping the **Show/Hide Toolbar** icon on the command bar.

To change the zoom magnification, tap **View**, tap **Zoom**, and then select the percentage that you want. Select a higher percentage to enter text and a lower percentage to see more of your document.

If you are opening a Word document created on a computer, select **Wrap to Window** on the **View** menu so that you can see the entire document.

## Pocket Excel

Pocket Excel works with Microsoft Excel on your computer to give you easy access to copies of your workbooks. You can create new workbooks on your device, or you can copy workbooks from your computer to your device. Synchronize workbooks between your computer and your device so that you have the most up-to-date content in both locations.

Use Pocket Excel to create workbooks, such as expense reports and mileage logs. To create a new file:

- 1 Tap the **Start** button → **Programs** → **Pocket Excel**.
- 2 Tap **New**.

A blank workbook appears. Or, if you selected a template for new workbooks in the **Options** dialog box, the template appears with appropriate text and formatting already provided.

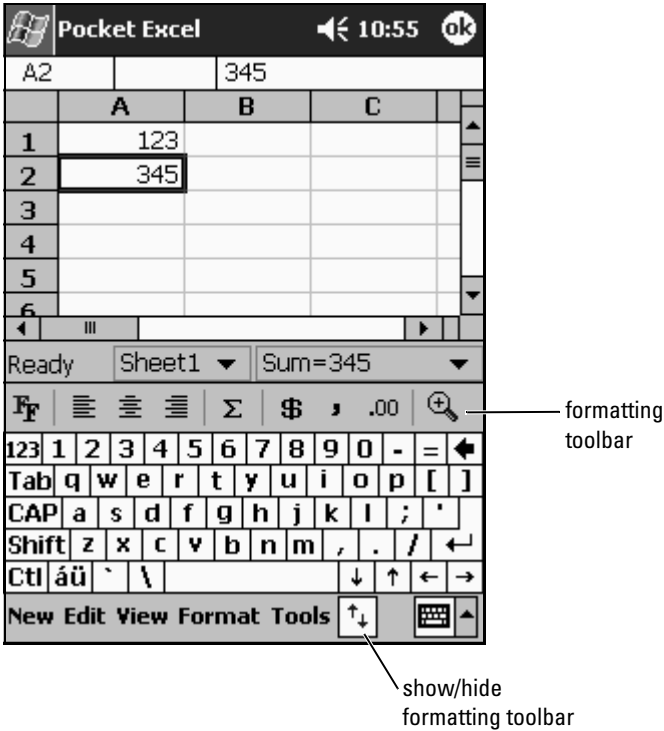

You can open only one workbook at a time. If you open a second workbook, you are asked to save the first one. You can create, save, or edit a workbook in a variety of formats, including Pocket Excel (.pxl) and Excel (.xls).

Pocket Excel contains a list of the files stored on your device. Tap a file in the list to open it. To delete, make copies of, or send files, tap and hold a file in the list. Then select the appropriate action from the pop-up menu.

Pocket Excel provides fundamental spreadsheet tools, such as formulas, functions, sorting, and filtering. To display the toolbar, tap **View** and tap **Toolbar**.



If your workbook contains sensitive information, you can protect it with a password. To set a password, open the workbook, tap **Edit**, and then tap **Password**. Every time you open the workbook, you need to enter the password, so choose one that is easy for you to remember but difficult for others to guess.

## Tips for Working in Pocket Excel

Use the following tips when working in large worksheets in Pocket Excel:

- Tap **View** and tap **Full Screen** to see as much of your worksheet as possible. To exit full-screen mode, tap **Restore**.
- Show and hide window elements. Tap **View** and then tap the elements that you want to show or hide.
- Freeze panes on a worksheet. First select the cell where you want to freeze panes. Tap **View** and tap **Freeze Panes**. You might want to freeze the top and leftmost panes in a worksheet to keep row and column labels visible as you scroll through a sheet.
- Split panes to view different areas of a large worksheet. Tap **View** and tap **Split**. Drag the split bar to where you want it. To remove the split, tap **View** and tap **Remove Split**.
- Show and hide rows and columns. To hide a row or column, select a cell in the row or column you want to hide. Tap **Format**, tap **Row** or **Column**, and then tap **Hide**. To show a hidden row or column, tap **Tools**, tap **Go To**, and then type a reference that is in the hidden row or column. Then tap **Format**, tap **Row** or **Column**, and then tap **Unhide**.

For more information on using Pocket Excel, tap the **Start** button and tap **Help**.

## MSN Messenger

With the MSN Messenger instant message program, you can:

- See who is online.
- Send and receive instant messages.
- Have instant message conversations with groups of contacts.

To use MSN Messenger, you must have a Microsoft Passport account or a Microsoft Exchange e-mail account. You must have a Passport to use MSN Messenger Service. If you have a Hotmail or MSN account, you already have a Passport. Once you have obtained either a Microsoft Passport or a Microsoft Exchange account, you are ready to set up your account.



**NOTE:** Sign up for a Microsoft Passport account at [www.passport.com](http://www.passport.com). Get a free Microsoft Hotmail e-mail address at [www.hotmail.com](http://www.hotmail.com).

To switch to MSN Messenger, tap the **Start** button → **Programs** → **MSN Messenger**.

## Setting Up

Before you can connect, you must enter Passport or Exchange account information.

To set up an account and sign in:

- 1 Tap the **Start** button → **Programs** → **MSN Messenger**.
- 2 Tap **Tools** and tap **Options**.
- 3 On the **Accounts** tab, enter your Passport or Exchange account information.
- 4 To sign in, tap the sign-in screen and enter your e-mail address and password.

## Working With Contacts

The MSN Messenger window shows all of your messenger contacts at a glance, divided into **Online** and **Not Online** categories. From this view, while connected, you can chat, send an e-mail, block the contact from chatting with you, or delete contacts from your list using the pop-up menu.



**NOTE:** If you already use MSN Messenger on your computer, your contacts show up on your device without having to be added.

To see others online without them seeing you, tap **Tools** → **My Status** → **Appear Offline**.

If you block a contact, you appear offline but remain on the blocked contact's list. To unblock a contact, tap and hold the contact, and then tap **Unblock** on the pop-up menu.

## Chatting With Contacts

- Tap a contact name to open a chat window. Enter your message in the text entry area at the bottom of the screen or tap **My Text** to enter a preset message, and then tap **Send**.
- To invite another contact to a multiuser chat, tap **Tools**, tap **Invite**, and then tap the contact you want to invite.
- To switch back to the main window without closing a chat, tap the **Contacts** icon. To revert back to your chat window, tap **Chats**, and select the person with whom you were chatting.
- To know if the contact you are chatting with is responding, look for the message under the text entry area.

For more information on using MSN Messenger, tap the **Start** button and tap **Help**.

## Microsoft Windows Media<sup>®</sup> Player for Pocket PC

Use Windows Media Player for Pocket PC to play digital audio and video files that are stored on your device or on a network. To switch to Windows Media Player for Pocket PC, tap the **Start** button → **Programs** → **Windows Media**.

Use Windows Media Player on your computer to copy digital audio and video files to your Pocket PC. You can play Windows Media and MP3 files on your Pocket PC.

For more information about using Windows Media Player for Pocket PC, tap the **Start** button and tap **Help**.



# Using Microsoft<sup>®</sup> Pocket Internet Explorer

Use Pocket Internet Explorer to view Web or WAP pages:

- During synchronization with your computer, download your favorite links and mobile favorites that are stored in the **Mobile Favorites** subfolder in Internet Explorer on your computer.
- Connect to an Internet service provider (ISP) or network and browse the Web. For more information on connecting to the Internet, see "Getting Connected" on page 91.

When the device is connected to an ISP or network, you can also download files and programs from the Internet or intranet.

To switch to Pocket Internet Explorer, tap the **Start** button and tap **Internet Explorer**.

## Mobile Favorites

If you are using Microsoft Internet Explorer 5.0 or later on your computer, you can download mobile favorites to your device. Synchronizing mobile favorites downloads Web content to your device so that you can view pages while you are disconnected from your ISP and computer. Use the Internet Explorer plug-in installed with Microsoft ActiveSync<sup>®</sup> to create mobile favorites quickly.

To create a mobile favorite on your computer and download it to your device:

- 1 On your computer, open Internet Explorer and click **Tools** → **Create Mobile Favorite**.
- 2 To change the link name, enter a new name in the **Name** box.
- 3 Specify an update schedule next to **Update** (optional).
- 4 Click **OK**.

Internet Explorer downloads the latest version of the page to your computer.

- 5 In Internet Explorer on the computer, right-click the mobile favorite and click **Properties**.
- 6 On the **Download** tab, specify the number of levels deep you want to download. To conserve device memory, go only one level deep.
- 7 Synchronize your device and computer.

Mobile favorites that are stored in the **Mobile Favorites** folder in Internet Explorer are downloaded to your device.

If you did not specify an update schedule in step 3, you need to manually download content to keep the information updated on your computer and device. Before synchronizing with your device, click **Tools** in Internet Explorer on your computer and click **Synchronize**. The date in the **Last Updated** column was the last time content was downloaded to the computer. You can manually download content, if necessary.



**NOTE:** You can add an icon to the Internet Explorer toolbar for creating mobile favorites. In Internet Explorer on your computer, click **View** → **Toolbars**, and then click **Customize**.

## Conserving Memory

Mobile favorites take up storage memory on your device. To minimize the amount of memory used:

- Turn off pictures and sounds or stop some mobile favorites from being downloaded to the device in the **Favorites** settings in the ActiveSync options. For more information, see ActiveSync Help on your computer.
- Limit the number of downloaded linked pages. In Internet Explorer on the computer, right-click the mobile favorite you want to change and click **Properties**. On the **Download** tab, specify **0** or **1** for the number of linked pages you want to download.

## Mobile Favorites Folder

Only items stored in the **Mobile Favorites** subfolder (in the **Favorites** folder) in Internet Explorer on your computer are synchronized with your device. The folder was created automatically when you installed ActiveSync.

## Favorite Links

During synchronization, the list of favorites in the **Mobile Favorites** folder on your computer is synchronized with Pocket Internet Explorer on your device. The computer and the device are updated with changes made to either list each time you synchronize. Unless you mark the favorite link as a mobile favorite, only the link is downloaded to your device—you need to connect to your ISP or network to view the content. For more information on synchronization, see ActiveSync Help on your computer.

## Using AvantGo Channels

AvantGo is a free interactive service that gives you access to personalized content and thousands of popular websites. You subscribe to AvantGo channels directly from your device. Then synchronize your device and computer, or connect to the Internet to download the content. For more information, see the AvantGo website.

To sign up for AvantGo:

- 1 In ActiveSync options on your computer, turn on synchronization for the **AvantGo** information type.
- 2 In Pocket Internet Explorer on your device, tap **Favorites** to display your list of favorites.
- 3 Tap the **AvantGo Channels** link.
- 4 Tap **Activate**.
- 5 Follow the directions on the screen.

You need to synchronize your device with your computer and then tap the **My Channels** to complete the AvantGo setup.

When synchronization is complete, tap the **AvantGo Channels** link in your list of favorites to see a few of the most popular channels. To add or remove channels, tap the **Add or Remove** link.

## Browsing Mobile Favorites and the Web

You can use Pocket Internet Explorer to browse mobile favorites and channels that you have downloaded to your device without connecting to the Internet. You can also connect to the Internet through an ISP or a network connection and browse the Web.



- back icon
- refresh icon
- home icon
- favorites icon

To view mobile favorites and channels:

- 1 Tap the favorites icon to display your list of favorites.
- 2 Tap the page you want to view.



The page that was downloaded the last time you synchronized with your computer appears. If the page is not on your device, the favorite is dimmed. You need to synchronize with your computer again to download the page to your device, or connect to the Internet to view the page.

To browse the Internet, set up a connection to your ISP or corporate network using **Connections**, as described in "Getting Connected" on page 91.



**NOTE:** To add a favorite link, go to the page that you want to add, tap and hold the page, and then tap **Add to Favorites**.

To connect to and browse the Internet:

- Tap the favorites icon and tap the favorite you want to view.
- Tap **View** and tap **Address Bar**. In the address bar that appears at the top of the screen, enter the Web address that you want to see and tap **Go**. Tap the arrow to select previously entered addresses.



## Getting Connected

You can use your device to exchange information with other mobile devices or with a computer, a network, or the Internet. You can use any of the following connection options:

- Use the infrared (IR) port on your device to send and receive files between two devices. See the following section, "Using Infrared," for more information.
- Connect to your Internet service provider (ISP). Once you are connected, you can send and receive e-mail messages by using Messaging, and view Web or WAP pages by using Microsoft® Pocket Internet Explorer. The communication software for creating an ISP connection is already installed on your device. Your service provider provides software needed to install other services, such as paging and fax services.
- Connect to the network at your company or organization where you work. Once you are connected, you can send and receive e-mail messages by using Messaging, view Web or WAP pages by using Pocket Internet Explorer, and synchronize with your computer.
- Connect to your computer to synchronize remotely. Once you are connected, you can synchronize information such as your Pocket Outlook information. See Microsoft ActiveSync® Help on your computer or Connections Help on the device for more information.

### Using Infrared

Using infrared, you can send and receive information, such as contacts and appointments, between two devices.

To send information:

- 1 Switch to the program where you created the item you want to send and locate the item in the list.
- 2 Align the infrared sensors so that they are unobstructed and within a close range.
- 3 Tap and hold the item, and tap **Beam xxxx** on the pop-up menu, where xxxx is the item that you want to beam.

You can also send items (excluding folders) from File Explorer. Tap and hold the item you want to send, and tap **Beam File** on the pop-up menu.

## Using Bluetooth® Wireless Technology

To configure a device with Bluetooth wireless technology in a Pocket PC environment:

- 1 From the lower-right corner of the **Today** screen, tap the icon for Bluetooth wireless technology, .
- 2 From the pop-up menu, select **Bluetooth Manager**.
- 3 To establish a connection with Bluetooth wireless technology, tap **New**.
- 4 Tap **Explore a Bluetooth device**.
- 5 Tap the remote device with Bluetooth wireless technology that you want to connect.
- 6 Tap the service that you want to use to create the connection.
- 7 Tap **Finish** to create the connection.
- 8 Tap and hold the connection created under **My Shortcuts** and tap **Connect**.
- 9 If the device to which you are trying to connect prompts you for a Passkey, enter the Passkey and tap **OK**.



**NOTE:** You need to get the passkey from the remote device with Bluetooth wireless technology.

An active connection with Bluetooth wireless technology is created and is ready to use.



**NOTE:** For more information about using Bluetooth wireless technology, tap the **Start** button → **Help** → **Bluetooth** to access the Microsoft Help on your device.

## Using Wi-Fi (802.11b)

To configure the Wireless Network in a PocketPC environment:

- 1 Press the wireless button to enable the wireless capability on your device.
- 2 Tap the **Start** button → **Settings** → **Connections** tab.

3 To add, edit, or delete a profile, tap **Network Cards**.



**NOTE:** If tapping the Network Cards icon does not open up the **Configure Wireless Networks** screen, enable the wireless radio by pressing the on/off button with WLAN/Bluetooth wireless technology on your device.

4 On the **Configure Wireless Networks** screen, select one of the available network names.



**NOTE:** If the network name is not listed, you must add a configuration profile for each wireless network environment in which you want to use your (mobile) wireless client station. If you plan to use your wireless client station in multiple networking environments that require different configuration settings, you can define dedicated profiles for each environment. For example, you can create a configuration profile for your office headquarters, a branch office, and your small office/home office.

- a If no network name is listed, tap **Add New Settings...** and type in the network name. Select the **The Internet** or **Work** connection method from the drop-down menu. If you want to set up a peer-to-peer connection, tap the **This is a device-to-device (ad-hoc) connection** check box.
- b Tap the **Network Key** tab to adjust the configurations. To disable encryption, tap the **Authentication** drop-down menu and tap **Open**. Now, select **Disabled** from the **Data Encryption** drop-down menu.
  - If you are using **Network Authentication (Shared mode)**, tap the **Authentication** drop-down menu, select **Shared**, and then select the proper encryption method from the **Data Encryption** drop-down menu.
  - If you do require encryption and are provided with the key automatically, the **The key is provided for me automatically** check box, when unchecked, allows you to enter the encryption key yourself. You can enter key values in either alphanumeric value or hexadecimal value. The encryption key value is case-sensitive. Consult your LAN Administrator or wireless router documentation for the correct value.

If you are using IEEE 802.1x option you will first need to get a certificate through a non 802.1x enabled wireless network connected to a certificate server. Select or configure a non 802.1x enabled wireless network from the list.

## Creating a Modem Connection

- 1 Install a modem card and appropriate adapters to connect an external modem to your device through the serial port.
- 2 Obtain the following information from your ISP:
  - ISP dial-up access telephone number
  - Username and password
  - TCP/IP settings

Some ISPs require information in front of the username, such as *MSN/username*.

- 3 Tap the **Start** button → **Settings** → **Connections** tab → **Connections**.
- 4 Under **My ISP** or **My Work Network**, tap **Add a new modem connection**.
- 5 Enter a name for the connection, such as **ISP Connection**.
- 6 From the **Select a modem** list, select your modem type, and tap **Next**.  
If your modem type does not appear, try reinserting the modem card. If you are using an external modem that is connected to your device with a cable, select **Hayes Compatible on COM1**.
- 7 Enter the access phone number and tap **Next**.
- 8 Enter your user name, password, and, if applicable, your domain.



**NOTE:** You should not need to change any settings in **Advanced**. Most ISPs now use a dynamically assigned address.

- 9 If the ISP you are connecting to does not use a dynamically assigned address, tap **Advanced**, tap the **TCP/IP** tab, and then enter the address.
- 10 Tap **Next**.
- 11 Select other appropriate options and tap **Finish**.

When you open Messaging, Pocket Internet Explorer, or MSN Messenger, your device automatically connects. Once you are connected, you can:

- Send and receive e-mail messages using Messaging. Before you can use Messaging, you need to provide the information Messaging needs to communicate with the e-mail server. See "Connecting Directly to an E-Mail Server" on page 97 for more information.
- See Web and WAP pages using Pocket Internet Explorer. For more information, see "Using Microsoft® Pocket Internet Explorer" on page 85.
- Send and receive instant messages with MSN Messenger. For more information, see "MSN Messenger" on page 81.

## Creating an Ethernet Connection

- 1 Contact your network administrator to obtain a user name, password, and domain name.
- 2 Install the network card driver, if required. For more information, see the documentation that came with your network card.
- 3 The Network Settings window appears automatically the first time you insert the network card so that you can configure the network card. To change settings later, tap the **Start** button →**Settings** →**Connections** tab →**Connections**.
- 4 If you need to enter specific server information, tap the appropriate adapter, and then tap **Properties**. You may need to enter proxy server and VPN connection settings. For more information, see your network administrator.



**NOTE:** Most networks use DHCP, so you do not need to change the connection settings unless your network administrator instructs you to do so.

- 5 If necessary, connect the network card to the network by using a network cable. For more information, see the documentation that came with your network card.

## Creating a VPN Connection

- 1 Tap the **Start** button → **Settings** → **Connections** tab → **Connections**.
- 2 Tap **Add a new VPN server connection**.
- 3 Enter a name for the connection, such as the name of your company.
- 4 In the **Host name/IP** field, enter the VPN server name or IP address.
- 5 Depending on the type of authentication that you want to use with your device, tap **IPSec** or **PPTP** next to **VPN type**.

If you are unsure about which option to select, contact your network administrator.

- 6 Tap **Next** and enter your username, password, and, if required, domain.
- 7 Install the network card driver, if required. For more information, see the documentation that came with your network card.
- 8 Insert the network card into your device.
  - If a network with a broadcast SSID is detected, the wireless network icon, , and the **New Network Detected** bubble appear in the navigation bar. Go to step 9.
  - If a network with a broadcast SSID is not detected, skip to step 10.
- 9 Tap **The Internet**.



**NOTE:** If multiple networks are detected, tap the network to which you want to connect, tap **The Internet**, and tap **Connect**.

- 10 Tap the **Start** button → **Settings** → **Connections** tab → **Connections**.
- 11 Tap the **Wireless Ethernet** icon.
- 12 On the **Wireless** tab, tap **New Settings**.
- 13 Enter the SSID next to **Network Name**, and tap **The Internet**.
- 14 Tap the **Authentication** tab to enable or disable WEP settings, depending on your network type.
- 15 Tap **OK**.
- 16 Tap the connection icon, , that appears in the navigation bar.
- 17 Tap the name of your VPN connection to enable it.



## Ending a Connection

To disconnect:

- When connected through dial-up or VPN, tap the connection icon, , on your navigation bar and tap **End**.
- When connected through a cable or cradle, detach your device from the cable or cradle.
- When connected through the infrared sensor, move the device away from the computer.
- When connected through a network (Ethernet) card, remove the card from your device.

## Connecting Directly to an E-Mail Server

You can set up a connection to an e-mail server so that you can send and receive e-mail messages by using a modem or network connection and Messaging on your device.



**NOTE:** The ISP or network must use a POP3 or IMAP4 e-mail server and an SMTP gateway.

You can use multiple e-mail services to receive your messages. For each e-mail service you intend to use, you must first set up and name the e-mail service. If you use the same service to connect to different mailboxes, set up and name each mailbox connection.

To set up an e-mail service:

- 1** In **Messaging** on your device, tap **Accounts** and tap **New Account**.
- 2** Follow the directions in the E-mail Setup wizard.

For more information, tap the **Start** button and tap **Help**.

To connect to your e-mail server, tap **Account** and tap **Connect**. For more information on using the Messaging program, see "Messaging" on page 64.

## Getting Help on Connecting

For more information on getting connected, see the following resources:

- "Messaging" on page 64.
- Online Help on the device. Tap the **Start** button and tap **Help**. Tap **Messaging** or **Connections**.
- ActiveSync Help on your computer. In ActiveSync, click **Help** and click **Microsoft ActiveSync Help**.
- See [www.microsoft.com/windowsmobile](http://www.microsoft.com/windowsmobile) for troubleshooting information.

# Appendix

## Specifications

---

### System Information

---

Processor	Intel® XScale™ PXA270 processor at up to 624 MHz
Memory	
RAM	64-MB SDRAM
ROM	64-MB or 128-MB Intel® StrataFlash™ ROM
Operating System	Microsoft® Windows Mobile™ 2003 Second Edition

---

### Display

---

Type	QVGA, VGA TFT Color 16-bit, touch-sensitive, transfective display
Size	3.5 inches (QVGA) 3.7 inches (VGA)
Resolution	240 x 320 at 65,536 colors (QVGA) 480 x 640 at 65,536 colors (VGA)
LCD brightness	QVGA: 100 nits VGA: 80 nits

---

### Controls and Lights

---

Navigation	5-way navigation button
Buttons:	four program buttons: Calendar, Contacts, Messaging, Home power on/off

---

**Controls and Lights (continued)**

---

Lights:	on/off button for WLAN/Bluetooth® wireless technology
	voice record button
	reset button
	lock button
	synchronization/communication
	event notification
	charge status

---

**Expansion Slots**

---

Secure Digital memory card	one Secure Digital memory card slot (3.3v) supports 1-bit and 4-bit SDIO card
CompactFlash card	one CompactFlash Type II card slot (3.3v)

---

**Ports and Connectors**

---

Infrared	standard v1.2 (115 kbps)
Cradle/synchronization connector	36-pin connector
Audio	stereo headphone connector and mono microphone connector

---

**Physical**

---

## Dimensions:

Length	119.0 mm (4.69 inches)
Width	73.0 mm (2.87 inches)
Height	16.9 mm (0.67 inch)

---

**Physical (continued)**

---

Weight	165 g (0.36 lb) QVGA with standard battery 175 g (0.38 lb) VGA with standard battery <b>NOTE:</b> The weight described refers to the device, not including the CompactFlash card or the Secure Digital memory card.
--------	---

---

**Audio**

---

Audio controller	WM8750L sound chip
Stereo conversion	16-bit stereo; 8.0-, 11.025-, 22.05-, and 44.1-KHz sample rate
Record	full duplex record and playback
Microphone/speaker	integrated
Headphone	stereo connector

---

**Wireless Connectivity**

---

WLAN (802.11b)	
Host interface	CF
Network standard	IEEE 802.11b
Data rate	1 Mbps, 2 Mbps, 5.5 Mbps, 11 Mbps
Modulation	CCK (11 Mbps, 5.5 Mbps); DQPSK (2 Mbps); DBSPK (1 Mbps)
Network architecture	ad-hoc and infrastructure
Operating frequencies	2.4–2.497 GHz
Operating channels	1–11 (North America); 1–13 (Europe and Japan)
RF output power	13.0 dBm maximum
Range	indoor — up to 10 m (120 ft) at 5 Mbps and 75 m at 0.5 Mbps
Client utility	automatic location profile, site survey, diagnostics, current link status, ping

---

**Wireless Connectivity (continued)**

---

Software support	Wi-Fi certified
Lights	green (WLAN status) blue (Bluetooth wireless technology status)
Switch	manual radio on/off (hardware button and software switch) to comply with aviation restrictions
Bluetooth wireless technology	2.4-GHz ISM band operation; compatible Bluetooth 1.2 wireless technology; includes manager for Bluetooth with wireless technology; Class II device; Max 4 dBm o/p power; 3.3V operation; UART interface

---

**Power Supply**

---

## Battery type:

Main	1100-mAh lithium-ion removable, rechargeable battery (standard) 2200-mAh lithium-ion removable, rechargeable battery (optional)
Backup	20-mAh rechargeable nickel metal hydride button cell

## AC adapter:

Supply voltage	100–240 VAC
Frequency	50–60 Hz
Current consumption	0.4 A
Output voltage	5.4 VDC
Output current	2.41 A

---

**Environmental**

---

## Temperature range:

operating	0° to 40°C (32° to 104°F)
storage	-20° to 60°C (-4° to 140°F)

## Thermal gradient:

operating	15°C (59°F) per hour maximum
storage	20°C (68°F) per hour maximum

## Relative humidity (maximum):

operating	10% to 90% non-condensing
storage	5% to 95% non-condensing

## Altitude (maximum):

operating	0 to 3048 m (0 to 10,000 ft)
storage	0 to 12,190 m (0 to 40,000 ft)

## Maximum shock (measured with a 2 ms half-sine pulse):

operating	200 G
storage	400 G

## Maximum vibration (using a random-vibration spectrum that simulates user environment):

operating	2.6 GRMS
storage	3.41 GRMS

# U.S. Terms and Conditions of Sale

These terms and conditions ("Agreement") apply to your purchase of computer systems and/or related products and/or services and support sold in the United States ("Product") by the Dell entity named on the invoice or acknowledgement ("Dell") provided to you. By accepting delivery of the Product, you accept and are bound to the terms and conditions of this Agreement. If you do not wish to be bound by this Agreement, you must notify Dell immediately and return your purchase pursuant to Dell's Total Satisfaction Return Policy. (See: [support.dell.com/ContactUs/ByPhone.aspx?c=us&l=en&s=gen](http://support.dell.com/ContactUs/ByPhone.aspx?c=us&l=en&s=gen) for our contact information.) If returned, Product(s) must remain in the boxes in which they were shipped. THIS AGREEMENT SHALL APPLY UNLESS (I) YOU HAVE A SEPARATE PURCHASE AGREEMENT WITH DELL, IN WHICH CASE THE SEPARATE AGREEMENT SHALL GOVERN; OR (II) OTHER DELL TERMS AND CONDITIONS APPLY TO THE TRANSACTION.

## 1 Other Documents.

This Agreement may NOT be altered, supplemented, or amended by the use of any other document(s) unless otherwise agreed to in a written agreement signed by both you and Dell. If you do not receive an invoice or acknowledgement in the mail, via e-mail, or with your Product, information about your purchase may be obtained at [support.dell.com/dellcare/Invoice.aspx](http://support.dell.com/dellcare/Invoice.aspx) or by contacting your sales representative.

## 2 Payment Terms; Orders; Quotes; Interest.

Payment terms are within Dell's sole discretion, and, unless otherwise agreed to by Dell, payment must be made at the time of purchase. Payment for Product may be made by credit card, wire transfer, or some other prearranged payment method. Dell may invoice parts of an order separately. Your order is subject to cancellation by Dell, at Dell's sole discretion. Unless you and Dell have agreed to a different discount, Dell's standard pricing policy for Dell-branded systems, which include both hardware and services in one discounted price, allocates the discount off list price applicable to the service portion of the system to be equal to the overall calculated percentage discount off list price on the entire system. Dell is not responsible for pricing, typographical, or other errors, in any offer by Dell and reserves the right to cancel any orders resulting from such errors.

## 3 Shipping Charges; Taxes; Title; Risk of Loss.

Shipping and handling are additional unless otherwise expressly indicated at the time of sale. Loss or damage that occurs during shipping by a carrier selected by Dell is Dell's responsibility. Loss or damage that occurs during shipping by a carrier selected by you is your responsibility. You must notify Dell within 30 days of the date of your invoice or acknowledgement if you believe any part of your purchase is missing wrong or damaged. Unless you provide Dell with a valid and correct tax exemption certificate applicable to your purchase of Product and the Product ship-to location, you are responsible for sales and other taxes associated with the order. Shipping dates are estimates only. Title to software will remain with the applicable licensor(s).



#### **4 Warranties.**

THE LIMITED WARRANTIES APPLICABLE TO DELL-BRANDED HARDWARE PRODUCT CAN BE FOUND AT [www.dell.com/policy/legal/warranty.htm](http://www.dell.com/policy/legal/warranty.htm) OR IN THE DOCUMENTATION DELL PROVIDES WITH THE PRODUCT. DELL MAKES NO WARRANTIES FOR SERVICE, SOFTWARE, OR NON-DELL BRANDED PRODUCT. SUCH PRODUCT IS PROVIDED BY DELL "AS IS". WARRANTY AND SERVICE FOR NON-DELL BRANDED PRODUCT, IF ANY, IS PROVIDED BY THE ORIGINAL MANUFACTURER, NOT BY DELL. DELL MAKES NO EXPRESS WARRANTIES EXCEPT THOSE STATED IN DELL'S APPLICABLE WARRANTY STATEMENT IN EFFECT ON THE DATE OF THE INVOICE, PACKING SLIP OR ACKNOWLEDGEMENT. WARRANTIES AND SERVICE WILL BE EFFECTIVE, AND DELL WILL BE OBLIGATED TO HONOR ANY SUCH WARRANTIES AND SERVICES, ONLY UPON DELL'S RECEIPT OF PAYMENT IN FULL FOR THE ITEM TO BE WARRANTED OR SERVICED.

#### **5 Software.**

All software is provided subject to the license agreement that is part of the software package and you agree that you will be bound by such license agreement.

#### **6 Return Policies; Exchanges.**

New and refurbished Product that you purchase directly from Dell (and not a third party) you may return or exchange only in accordance with Dell's return policy in effect on the date of the invoice or acknowledgement. Any returns or exchanges will be made in accordance with Dell's exchange policies in effect on the date of the return or exchange. You must contact us directly before you attempt to return Product to obtain a Return Material Authorization Number for you to include with your return. You must return Product to us in their original or equivalent packaging. You are responsible for risk of loss, shipping and handling fees for returning or exchanging Product. Additional fees may apply. Dell's return policy for Dell-branded Product can be found at: [www.dell.com/policy/legal/warranty.htm](http://www.dell.com/policy/legal/warranty.htm). Non-Dell branded software and peripheral return policies can be found at:

[www.rcommerce.us.dell.com/rcomm/include/dw\\_policies.htm](http://www.rcommerce.us.dell.com/rcomm/include/dw_policies.htm).

Refurbished Product return policies can be found at:

[www.dell.com/us/en/dfh/topics/segtopic\\_nav\\_info\\_002\\_info.htm](http://www.dell.com/us/en/dfh/topics/segtopic_nav_info_002_info.htm). If you fail to follow the return or exchange instructions and policies provided by Dell, Dell is not responsible whatsoever for Product that is lost, damaged, modified or otherwise processed for disposal or resale. If you are returning all components in an order, you will be credited the full amount paid for the order. At Dell's discretion, credit for partial returns may be less than invoice or individual component prices due to bundled or promotional pricing.

#### **7 Changed or Discontinued Product.**

Dell's policy is one of ongoing update and revision. Dell may revise and discontinue Product at any time without notice to you and this may affect information saved in your online "cart." Dell will ship Product that have the functionality and performance of the Product ordered, but changes between what is shipped and what is described in a specification sheet or catalog are possible. Parts used in repairing or servicing Product may be new, equivalent-to-new, or reconditioned.

## **8 Service and Support.**

Service offerings may vary from Product to Product. If you purchase optional services and support from Dell, Dell and/or your third-party service provider will provide such service and support to you in the United States in accordance with the terms and conditions located at [www.dell.com/us/en/gen/services/service\\_service\\_contracts.htm](http://www.dell.com/us/en/gen/services/service_service_contracts.htm) or as mailed to you. You may contact Dell for more information, see

[www1.us.dell.com/content/topics/segtopic.aspx/contact/contact?c=us&l=en&s=gen](http://www1.us.dell.com/content/topics/segtopic.aspx/contact/contact?c=us&l=en&s=gen) for contact information. Dell and/or the third-party service provider may at their discretion, revise their general and optional service and support programs and the terms and conditions that govern them without prior notice to you. Dell has no obligation to provide service or support until Dell has received full payment for the Product or service/support contract you purchased. Dell is not obligated to provide service or support you purchase through a third party and not Dell.

## **9 Limitation of Liability.**

DELL DOES NOT ACCEPT LIABILITY BEYOND THE REMEDIES SET FORTH HEREIN, INCLUDING BUT NOT LIMITED TO ANY LIABILITY FOR PRODUCT NOT BEING AVAILABLE FOR USE, LOST PROFITS, LOSS OF BUSINESS OR FOR LOST OR CORRUPTED DATA OR SOFTWARE, OR THE PROVISION OF SERVICES AND SUPPORT. EXCEPT AS EXPRESSLY PROVIDED HEREIN, DELL WILL NOT BE LIABLE FOR ANY CONSEQUENTIAL, SPECIAL, INDIRECT, OR PUNITIVE DAMAGES, EVEN IF ADVISED OF THE POSSIBILITY OF SUCH DAMAGES, OR FOR ANY CLAIM BY ANY THIRD PARTY. YOU AGREE THAT FOR ANY LIABILITY RELATED TO THE PURCHASE OF PRODUCT, DELL IS NOT LIABLE OR RESPONSIBLE FOR ANY AMOUNT OF DAMAGES ABOVE THE AMOUNT INVOICED FOR THE APPLICABLE PRODUCT. NOTWITHSTANDING ANYTHING IN THIS AGREEMENT TO THE CONTRARY, THE REMEDIES SET FORTH IN THIS AGREEMENT SHALL APPLY EVEN IF SUCH REMEDIES FAIL THEIR ESSENTIAL PURPOSE. **DELL IS NOT LIABLE TO YOU FOR WARRANTIES, SUPPORT, OR SERVICE MADE BY OR PURCHASED FROM A THIRD PARTY AND NOT DIRECTLY FROM DELL. DELL IS NOT RESPONSIBLE FOR REPRESENTATIONS OR OMISSIONS MADE BY A THIRD PARTY.**

## **10 Applicable Law; Not For Resale or Export.**

You agree to comply with all applicable laws and regulations of the various states and of the United States. You agree and represent that you are buying only for your own internal use only, and not for resale or export. Dell has separate terms and conditions governing resale of Product by third parties and transactions outside the United States. Terms and conditions for resale are located at: [www.dell.com/policy/legal/termsofsale.htm](http://www.dell.com/policy/legal/termsofsale.htm).

## **11 Governing Law.**

**THIS AGREEMENT AND ANY SALES THERE UNDER SHALL BE GOVERNED BY THE LAWS OF THE STATE OF TEXAS, WITHOUT REGARD TO CONFLICTS OF LAWS RULES.**

## **12** Headings.

The section headings used herein are for convenience of reference only and do not form a part of these terms and conditions, and no construction or inference shall be derived there from.

## **13** Binding Arbitration.

ANY CLAIM, DISPUTE, OR CONTROVERSY (WHETHER IN CONTRACT, TORT, OR OTHERWISE, WHETHER PREEXISTING, PRESENT OR FUTURE, AND INCLUDING STATUTORY, COMMON LAW, INTENTIONAL TORT AND EQUITABLE CLAIMS) BETWEEN CUSTOMER AND DELL, its agents, employees, principals, successors, assigns, affiliates (collectively for purposes of this paragraph, "Dell") arising from or relating to this Agreement, its interpretation, or the breach, termination or validity thereof, the relationships which result from this Agreement (including, to the full extent permitted by applicable law, relationships with third parties who are not signatories to this Agreement), Dell's advertising, or any related purchase SHALL BE RESOLVED EXCLUSIVELY AND FINALLY BY BINDING ARBITRATION ADMINISTERED BY THE NATIONAL ARBITRATION FORUM (NAF) under its Code of Procedure then in effect (available via the Internet at [www.arb-forum.com](http://www.arb-forum.com) , or via telephone at 1-800-474-2371). The arbitration will be limited solely to the dispute or controversy between customer and Dell. NEITHER CUSTOMER NOR DELL SHALL BE ENTITLED TO JOIN OR CONSOLIDATE CLAIMS BY OR AGAINST OTHER CUSTOMERS, OR ARBITRATE ANY CLAIM AS A REPRESENTATIVE OR CLASS ACTION OR IN A PRIVATE ATTORNEY GENERAL CAPACITY. This transaction involves interstate commerce, and this provision shall be governed by the Federal Arbitration Act 9 U.S.C. sec. 1-16 (FAA). Any award of the arbitrator(s) shall be final and binding on each of the parties, and may be entered as a judgment in any court of competent jurisdiction. Dell will be responsible for paying any arbitration filing fees and fees required to obtain a hearing to the extent such fees exceed the amount of the filing fee for initiating a claim in the court of general jurisdiction in the state in which you reside. Each party shall pay for its own costs and attorneys' fees, if any. However, if any party prevails on a statutory claim that affords the prevailing party attorneys' fees, or if there is a written agreement providing for fees, the Arbitrator may award reasonable fees to the prevailing party, under the standards for fee shifting provided by law. Information may be obtained and claims may be filed with the NAF at P.O. Box 50191, Minneapolis, MN 55405. (REV 4/04)

# **Dell™ Software License Agreement**

This is a legal agreement between you, the user, and Dell Products, L.P ("Dell"). This agreement covers all software that is distributed with the Dell product, for which there is no separate license agreement between you and the manufacturer or owner of the software (collectively the "Software"). This agreement is not for the sale of Software or any other intellectual property. All title and intellectual property rights in and to Software is owned by the manufacturer or owner of the Software. All rights not expressly granted under this agreement are reserved by the manufacturer or owner of the Software. By opening or breaking the seal on the Software packet(s), installing or downloading the Software, or using

the Software that has been preloaded or is embedded in your product, you agree to be bound by the terms of this agreement. If you do not agree to these terms, promptly return all Software items (disks, written materials, and packaging) and delete any preloaded or embedded Software.

You may use one copy of the Software on only one product at a time. If you have multiple licenses for the Software, you may use as many copies at any time as you have licenses. "Use" means loading the Software in temporary memory or permanent storage on the product. Installation on a network server solely for distribution to other products is not "use" if (but only if) you have a separate license for each product to which the Software is distributed. You must ensure that the number of persons using the Software installed on a network server does not exceed the number of licenses that you have. If the number of users of Software installed on a network server will exceed the number of licenses, you must purchase additional licenses until the number of licenses equals the number of users before allowing additional users to use the Software. If you are a commercial customer of Dell or a Dell affiliate, you hereby grant Dell, or an agent selected by Dell, the right to perform an audit of your use of the Software during normal business hours, you agree to cooperate with Dell in such audit, and you agree to provide Dell with all records reasonably related to your use of the Software. The audit will be limited to verification of your compliance with the terms of this agreement.

The Software is protected by United States copyright laws and international treaties. You may make one copy of the Software solely for backup or archival purposes or transfer it to a single hard disk provided you keep the original solely for backup or archival purposes. You may not rent or lease the Software or copy the written materials accompanying the Software, but you may transfer the Software and all accompanying materials on a permanent basis as part of a sale or transfer of the Dell product if you retain no copies and the recipient agrees to the terms hereof. Any transfer must include the most recent update and all prior versions. You may not reverse engineer, decompile, or disassemble the Software. If the package accompanying your product contains compact discs, 3.5", and/or 5.25" disks, you may use only the disks appropriate for your product. You may not use the disks on another product or network, or loan, rent, lease, or transfer them to another user except as permitted by this agreement.

## Limited Warranty

Dell warrants that the Software disks will be free from defects in materials and workmanship under normal use for ninety (90) days from the date you receive them. This warranty is limited to you and is not transferable. Any implied warranties are limited to ninety (90) days from the date you receive the Software. Some jurisdictions do not allow limits on the duration of an implied warranty, so this limitation may not apply to you. The entire liability of Dell and its suppliers, and your exclusive remedy, shall be (a) return of the price paid for the Software or (b) replacement of any disk not meeting this warranty that is sent with a return authorization number to Dell, at your cost and risk. This limited warranty is void if any disk damage has resulted from accident, abuse, misapplication, or service or modification by someone other than Dell. Any replacement disk is warranted for the remaining original warranty period or thirty (30) days, whichever is longer.

Dell does NOT warrant that the functions of the Software will meet your requirements or that operation of the Software will be uninterrupted or error free. You assume responsibility for selecting the Software to achieve your intended results and for the use and results obtained from the Software.

DELL, ON BEHALF OF ITSELF AND ITS SUPPLIERS, DISCLAIMS ALL OTHER WARRANTIES, EXPRESS OR IMPLIED, INCLUDING, BUT NOT LIMITED TO, IMPLIED WARRANTIES OF MERCHANTABILITY AND FITNESS FOR A PARTICULAR PURPOSE, FOR THE SOFTWARE AND ALL ACCOMPANYING WRITTEN MATERIALS. This limited warranty gives you specific legal rights; you may have others, which vary from jurisdiction to jurisdiction.

IN NO EVENT SHALL DELL OR ITS SUPPLIERS BE LIABLE FOR ANY DAMAGES WHATSOEVER (INCLUDING, WITHOUT LIMITATION, DAMAGES FOR LOSS OF BUSINESS PROFITS, BUSINESS INTERRUPTION, LOSS OF BUSINESS INFORMATION, OR OTHER PECUNIARY LOSS) ARISING OUT OF USE OR INABILITY TO USE THE SOFTWARE, EVEN IF ADVISED OF THE POSSIBILITY OF SUCH DAMAGES. Because some jurisdictions do not allow an exclusion or limitation of liability for consequential or incidental damages, the above limitation may not apply to you.

### **U.S. Government Restricted Rights**

The software and documentation are "commercial items" as that term is defined at 48 C.F.R. 2.101, consisting of "commercial computer software" and "commercial computer software documentation" as such terms are used in 48 C.F.R. 12.212. Consistent with 48 C.F.R. 12.212 and 48 C.F.R. 227.7202-1 through 227.7202-4, all U.S. Government end users acquire the software and documentation with only those rights set forth herein. Contractor/manufacturer is Dell Products, L.P., One Dell Way, Round Rock, Texas 78682.

### **General**

This license is effective until terminated. It will terminate upon the conditions set forth above or if you fail to comply with any of its terms. Upon termination, you agree that the Software and accompanying materials, and all copies thereof, will be destroyed. This agreement is governed by the laws of the State of Texas. Each provision of this agreement is severable. If a provision is found to be unenforceable, this finding does not affect the enforceability of the remaining provisions, terms, or conditions of this agreement. This agreement is binding on successors and assigns. Dell agrees and you agree to waive, to the maximum extent permitted by law, any right to a jury trial with respect to the Software or this agreement. Because this waiver may not be effective in some jurisdictions, this waiver may not apply to you. You acknowledge that you have read this agreement, that you understand it, that you agree to be bound by its terms, and that this is the complete and exclusive statement of the agreement between you and Dell regarding the Software.

# Regulatory Notices

Electromagnetic Interference (EMI) is any signal or emission, radiated in free space or conducted along power or signal leads, that endangers the functioning of a radio navigation or other safety service or seriously degrades, obstructs, or repeatedly interrupts a licensed radio communications service. Radio communications services include but are not limited to AM/FM commercial broadcast, television, cellular services, radar, air-traffic control, pager, and Personal Communication Services (PCS). These licensed services, along with unintentional radiators such as digital devices, including computers, contribute to the electromagnetic environment.

Electromagnetic Compatibility is the ability of items of electronic equipment to function properly together in the electronic environment. While this computer has been designed and determined to be compliant with regulatory agency limits for EMI, there is no guarantee that interference will not occur in a particular installation. If this equipment does cause interference with radio communications services, which can be determined by turning the equipment off and on, you are encouraged to try to correct the interference by one or more of the following measures:

- Reorient the receiving antenna.
- Relocate the computer with respect to the receiver.
- Move the computer away from the receiver.
- Plug the computer into a different outlet so that the computer and the receiver are on different branch circuits.

If necessary, consult a Dell Technical Support representative or an experienced radio/television technician for additional suggestions.

Dell™ computers are designed, tested, and classified for their intended electromagnetic environment. These electromagnetic environment classifications generally refer to the following harmonized definitions:

- Class A is typically for business or industrial environments.
- Class B is typically for residential environments.

Information Technology Equipment (ITE), including devices, expansion cards, printers, input/output (I/O) devices, monitors, and so on, that are integrated into or connected to the computer should match the electromagnetic environment classification of the computer.

**A Notice About Shielded Signal Cables:** Use only shielded cables for connecting devices to any Dell device to reduce the possibility of interference with radio communications services. Using shielded cables ensures that you maintain the appropriate Electromagnetic Compatibility classification for the intended environment. For parallel printers, a cable is available from Dell. If you prefer, you can order a cable from Dell on the World Wide Web at [accessories.us.dell.com/sna/category.asp?category\\_id=4117](http://accessories.us.dell.com/sna/category.asp?category_id=4117).

Most Dell computers are classified for Class B environments. However, the inclusion of certain options can change the rating of some configurations to Class A. To determine the electromagnetic classification for your computer or device, see the following sections specific for each regulatory agency. Each section provides country-specific Electromagnetic Compatibility/EMI or product safety information.

## **FCC Notices (U.S. Only)**

Most Dell computers are classified by the Federal Communications Commission (FCC) as Class B digital devices. To determine which classification applies to your computer, examine all FCC registration labels located on the bottom, side, or back panel of your computer, on card-mounting brackets, and on the cards themselves. If any one of the labels carries a Class A rating, your entire computer is considered to be a Class A digital device. If *all* labels carry an FCC Class B rating as distinguished by either an FCC ID number or the FCC logo, (**FCC**), your computer is considered to be a Class B digital device.

Once you have determined your computer's FCC classification, read the appropriate FCC notice. Note that FCC regulations provide that changes or modifications not expressly approved by Dell could void your authority to operate this equipment.

This device complies with Part 15 of the FCC Rules. Operation is subject to the following two conditions:

- This device may not cause harmful interference.
- This device must accept any interference received, including interference that may cause undesired operation.

## **Class B**

This equipment has been tested and found to comply with the limits for a Class B digital device pursuant to Part 15 of the FCC Rules. These limits are designed to provide reasonable protection against harmful interference in a residential installation. This equipment generates, uses, and can radiate radio frequency energy and, if not installed and used in accordance with the manufacturer's instruction manual, may cause interference with radio communications. However, there is no guarantee that interference will not occur in a particular installation. If this equipment does cause harmful interference to radio or television reception, which can be determined by turning the equipment off and on, you are encouraged to try to correct the interference by one or more of the following measures:

- Reorient or relocate the receiving antenna.
- Increase the separation between the equipment and the receiver.
- Connect the equipment into an outlet on a circuit different from that to which the receiver is connected.
- Consult the dealer or an experienced radio/television technician for help.

## FCC Identification Information

The following information is provided on the device or devices covered in this document in compliance with FCC regulations:

- Models: HC03U, HC03UL, and HD04U
- Company name:

Dell Inc.  
One Dell Way  
Round Rock, Texas 78682 USA  
512-338-4400

## IC Notice (Canada Only)

Most Dell computers (and other Dell digital apparatus) are classified by the Industry Canada (IC) Interference-Causing Equipment Standard #3 (ICES-003) as Class B digital devices. To determine which classification (Class A or B) applies to your computer (or other Dell digital apparatus), examine all registration labels located on the bottom, side, or the back panel of your computer (or other digital apparatus). A statement in the form of "IC Class A ICES-003" or "IC Class B ICES-003" will be located on one of these labels. Note that Industry Canada regulations provide that changes or modifications not expressly approved by Dell could void your authority to operate this equipment.

This Class B (or Class A, if so indicated on the registration label) digital apparatus meets the requirements of the Canadian Interference-Causing Equipment Regulations.

Cet appareil numérique de la Classe B (ou Classe A, si ainsi indiqué sur l'étiquette d'enregistrement) respecte toutes les exigences du Règlement sur le Matériel Brouilleur du Canada.

## CE Notice (European Union)

Marking by the symbol **CE** indicates compliance of this Dell computer to the Electromagnetic Compatibility Directive and the Low Voltage Directive of the European Union. Such marking is indicative that this Dell system meets the following technical standards:

- EN 55022 — "Information Technology Equipment — Radio Disturbance Characteristics — Limits and Methods of Measurement."
- EN 55024 — "Information Technology Equipment - Immunity Characteristics - Limits and Methods of Measurement."
- EN 61000-3-2 — "Electromagnetic Compatibility - Part 3: Limits - Section 2: Limits for Harmonic Current Emissions (Equipment Input Current Up to and Including 16 A Per Phase)."



- EN 61000-3-3 — "Electromagnetic Compatibility - Part 3: Limits - Section 3: Limitation of Voltage Fluctuations and Flicker in Low-Voltage Supply Systems for Equipment With Rated Current Up to and Including 16 A."
- EN 60950 — "Safety of Information Technology Equipment."

**NOTE:** EN 55022 emissions requirements provide for two classifications:

- Class A is for typical commercial areas.
- Class B is for typical domestic areas.

This Dell device is classified for use in a typical Class B domestic environment.

A "Declaration of Conformity" in accordance with the preceding directives and standards has been made and is on file at Dell Inc. Products Europe BV, Limerick, Ireland.

## CE Mark Notice

This equipment complies with the essential requirements of the European Union Directive 1999/5/EC.

Toto zařízení splňuje základní požadavky směrnice 1999/5/EC.

Dette udstyr opfylder de Væsentlige krav i EU's direktiv 1999/5/EC om Radio- og teleterminaludstyr.

Deze apparatuur voldoet aan de noodzakelijke vereisten van EU-richtlijn betreffende radioapparatuur en telecommunicatie-eindapparatuur 1999/5/EC.

Käesolev seade vastab oluliste Euroopa Liidu Direktiivi 1999/5/EC nõudmistele.

Tämä laite vastaa EU:n radio- ja telepäätelaidirektiivin (EU R&TTE Directive 1999/5/EC) vaatimuksia.

Cet équipement est conforme aux principales caractéristiques définies dans la Directive européenne RTTE 1999/5/CE.

Die Geräte erfüllen die grundlegenden Anforderungen der RTTE-Richtlinie (1999/5/EC).

Ο εξοπλισμός αυτός πληροί τις βασικές απαιτήσεις της κοινοτικής οδηγίας EU R&TTE 1999/5/ΕΚ.

A készülék megfelel az Európai Unió 1999/5/EC direktívája alapvető követelményeinek.

Questa apparecchiatura é conforme ai requisiti essenziali della Direttiva Europea R&TTE 1999/5/CE.

Št ierice atbilst nepieciešamajām Eiropas Savienības Direktīva prasībām 1999/5/EC.

Šis prietaisas atitinka būtiskus Eiropas Sąjungos direktyvos 1999/5/EC reikalavimus.

Dan it-tagħmir jikkonforma mar-reqwiżiti essenzjali tad-Direttiva ta' l-Unjoni Ewropea 1999/5/KE.

Dette utstyret er i overensstemmelse med hovedkravene i R&TTE-direktivet (1999/5/EC) fra EU.

To urządzenie spełnia podstawowe wymagania dyrektywy Unii Europejskiej 1999/5/EC.

Este equipamento cumple os requisitos essenciais da Directiva 1999/5/CE do Parlamento Europeu e do Conselho (Directiva RTT).

Toto zariadenie spĺňa základné požiadavky Direktívy Európskej únie č. 1999/5/EC.

Ta oprema je skladna z bistvenimi zahtevami direktive EU 1999/5/EC.

Este equipo cumple los requisitos principales de la Directiva 1999/5/CE de la UE, "Equipos de Terminales de Radio y Telecomunicaciones".

Utrustningen uppfyller kraven för EU-direktivet 1999/5/EC om ansluten teleutrustning och ömsesidigt erkännande av utrustningens överensstämmelse (R&TTE).

## Australia and New Zealand



## VCCI Notice (Japan Only)

Most Dell computers are classified by the Voluntary Control Council for Interference (VCCI) as Class B information technology equipment (ITE). However, the inclusion of certain options can change the rating of some configurations to Class A. ITE, including devices, expansion cards, printers, input/output (I/O) devices, monitors, and so on, integrated into or connected to the computer should match the electromagnetic environment classification (Class A or B) of the computer.

To determine which classification applies to your computer, examine the regulatory labels/markings (see "VCCI Class A ITE Regulatory Mark" and "VCCI Class B ITE Regulatory Mark") located on the bottom, side, or back panel of your computer. Once you have determined your computer's VCCI classification, read the appropriate VCCI notice.

### Class B ITE

この装置は、情報処理装置等電波障害自主規制協議会 (VCCI) の基準に基づくクラス B 情報技術装置です。この装置は家庭環境で使用することを目的としています。ラジオやテレビジョン受信機に近接して使用されると、受信障害を引き起こすことがあります。取扱説明書に従って正しい取り扱いをしてください。

This is a Class B product based on the standard of the Voluntary Control Council for Interference (VCCI) for information technology equipment. If this equipment is used near a radio or television receiver in a domestic environment, it may cause radio interference. Install and use the equipment according to the instruction manual.

### *VCCI Class B ITE Regulatory Mark*

If the regulatory label includes the following marking, your computer is a Class B product:



## MIC Notice (Republic of Korea Only)

To determine which classification (Class A or B) applies to your computer (or other Dell digital device), examine the Republic of Korean Ministry of Information and Communications (MIC) registration labels located on your computer (or other Dell digital device). The MIC label may be located separately from the other regulatory marking applied to your product. Line two of the label identifies the emissions class for the product—"A" for Class A products or "B" for Class B products.

**NOTE:** MIC emissions requirements provide for two classifications:

- Class A devices are for business purposes.
- Class B devices are for nonbusiness purposes.

### Class B Device

기종별	사용자 안내문
B급 기기 (가정용 정보통신기기)	이 기기는 가정용으로 전자파적합등록을 한 기기로서 주거지역에서는 물론 모든 지역에서 사용할 수 있습니다.

Please note that this device has been approved for nonbusiness purposes and may be used in any environment, including residential areas.

### MIC Class B Regulatory Label

If the regulatory label includes the following marking, your computer is a Class B product.



명칭/모델명: 델컴퓨터 / Pocket PC (HC02U, HD03U)  
 인증번호: Refer to Regulatory Label  
 인증받은자의 상호: 델 컴퓨터(주)  
 제조년월일: Refer to Regulatory Label  
 제조자/제조국: Refer to Regulatory Label  
 for Country of Origin

### Polish Center for Testing and Certification Notice

The equipment should draw power from a socket with an attached protection circuit (a 3-prong socket). All equipment that works together (computer, monitor, printer, and so on) should have the same power supply source.

The phasing conductor of the room's electrical installation should have a reserve short-circuit protection device in the form of a fuse with a nominal value no larger than 16 amperes (A).

To completely switch off the equipment, the power supply cable must be removed from the power supply socket, which should be located near the equipment and easily accessible.

A protection mark "B" confirms that the equipment is in compliance with the protection usage requirements of standards PN-93/T-42107 and PN-EN 55022.

## **Wymagania Polskiego Centrum Badań i Certyfikacji**

Urządzenie powinno być zasilane z gniazda z przyłączonym obwodem ochronnym (gniazdo z kołkiem). Współpracujące ze sobą urządzenia (komputer, monitor, drukarka) powinny być zasilane z tego samego źródła.

Instalacja elektryczna pomieszczenia powinna zawierać w przewodzie fazowym rezerwową ochronę przed zwarciami, w postaci bezpiecznika o wartości znamionowej nie większej niż 16A (amperów).

W celu całkowitego wyłączenia urządzenia z sieci zasilania, należy wyjąć wtyczkę kabla zasilającego z gniazdka, które powinno znajdować się w pobliżu urządzenia i być łatwo dostępne. Znak bezpieczeństwa "B" potwierdza zgodność urządzenia z wymaganiami bezpieczeństwa użytkowania zawartymi w PN-EN 60950:2000 i PN-EN 55022:2000.

Jeżeli na tabliczce znamionowej umieszczono informację, że urządzenie jest klasy A, to oznacza to, że urządzenie w środowisku mieszkalnym może powodować zakłócenia radioelektryczne. W takich przypadkach można żądać od jego użytkownika zastosowania odpowiednich środków zaradczych.

## Pozostałe instrukcje bezpieczeństwa

- Nie należy używać wtyczek adapterowych lub usuwać kołka obwodu ochronnego z wtyczki. Jeżeli konieczne jest użycie przedłużacza to należy użyć przedłużacza 3-żyłowego z prawidłowo połączonym przewodem ochronnym.
- System komputerowy należy zabezpieczyć przed nagłymi, chwilowymi wzrostami lub spadkami napięcia, używając eliminatora przepięć, urządzenia dopasowującego lub bezzakłóceniewego źródła zasilania.
- Należy upewnić się, aby nic nie leżało na kablach systemu komputerowego, oraz aby kable nie były umieszczone w miejscu, gdzie można byłoby na nie nadeptywać lub potykać się o nie.
- Nie należy rozlewać napojów ani innych płynów na system komputerowy.
- Nie należy wpychać żadnych przedmiotów do otworów systemu komputerowego, gdyż może to spowodować pożar lub porażenie prądem, poprzez zwarcie elementów wewnętrznych.
- System komputerowy powinien znajdować się z dala od grzejników i źródeł ciepła. Ponadto, nie należy blokować otworów wentylacyjnych. Należy unikać kładzenia luźnych papierów pod komputer oraz umieszczania komputera w ciasnym miejscu bez możliwości cyrkulacji powietrza wokół niego.

## NOM Information (Mexico Only)

The following information is provided on the device(s) described in this document in compliance with the requirements of the official Mexican standards (NOM):

Exporter:	Dell Inc. One Dell Way Round Rock, TX 78682
Importer:	Dell Computer de México, S.A. de C.V. Paseo de la Reforma 2620 - 11° Piso Col. Lomas Altas 11950 México, D.F.
Ship to:	Dell Computer de México, S.A. de C.V. al Cuidado de Kuehne & Nagel de México S. de R.I. Avenida Soles No. 55 Col. Peñon de los Baños 15520 México, D.F.
Models:	HC03U, HC03UL, and HD04U
Supply voltage:	100–240 VAC
Frequency:	50–60 Hz
Current Consumption:	0.4 A
Output voltage:	5.4 VDC
Output current:	2.41 A

## Wireless Regulatory Information

The Dell™ Axim™ X50 device must be used in strict accordance with the manufacturer's instructions as described in the user documentation that comes with the product. For country-specific approvals, see Radio approvals. Dell Inc. is not responsible for any radio or television interference caused by unauthorized modification of the device, or the substitution or attachment of connecting cables and equipment other than that specified by Dell Inc. The correction of interference caused by such unauthorized modification, substitution or attachment is the responsibility of the user. Dell Inc. and its authorized resellers or distributors are not liable for any damage or violation of government regulations that may arise from the user failing to comply with these guidelines.

## Europe—CE Declaration of Conformity

EN 301 489 v1.4.1 (December 2001), EN 301 489 v1.2.1 (December 2001), EN 300 328 v1.4.1 (August 2002), EN60950 (January 2000)



English	Hereby, Dell Inc. declares that this HC03U/HCO3UL is in compliance with the essential requirements and other relevant provisions of Directive 1999/5/EC.
Finnish	Dell Inc. vakuuttaa täten että HC03U/HCO3UL tyyppinen laite on direktiivin 1999/5/EY oleellisten vaatimusten ja sitä koskevien direktiivin muiden ehtojen mukainen.
Dutch	Hierbij verklaart Dell Inc. dat het toestel HC03U/HCO3UL in overeenstemming is met de essentiële eisen en de andere relevante bepalingen van richtlijn 1999/5/EG  Bij deze verklaart Dell Inc. dat deze HC03U/HCO3UL voldoet aan de essentiële eisen en aan de overige relevante bepalingen van Richtlijn 1999/5/EC.
French	Par la présente Dell Inc. déclare que l'appareil HC03U/HCO3UL est conforme aux exigences essentielles et aux autres dispositions pertinentes de la directive 1999/5/CE  Par la présente, Dell Inc. déclare que ce HC03U/HCO3UL est conforme aux exigences essentielles et aux autres dispositions de la directive 1999/5/CE qui lui sont applicables
Swedish	Härmed intygar Dell Inc. att denna HC03U/HCO3UL står i överensstämmelse med de väsentliga egenskapskrav och övriga relevanta bestämmelser som framgår av direktiv 1999/5/EG.
Danish	Undertegnede Dell Inc. erklærer herved, at følgende udstyr HC03U/HCO3UL overholder de væsentlige krav og øvrige relevante krav i direktiv 1999/5/EF



German	<p>Hiermit erklärt Dell Inc., dass sich <i>dieser/diese/dieses</i> HC03U/HCO3UL in Übereinstimmung mit den grundlegenden Anforderungen und den anderen relevanten Vorschriften der Richtlinie 1999/5/EG befindet". (BMW i)</p> <p>Hiermit erklärt Dell Inc. die Übereinstimmung des Gerätes HC03U/HCO3UL mit den grundlegenden Anforderungen und den anderen relevanten Festlegungen der Richtlinie 1999/5/EG. (Wien)</p>
Greek	<b>ΜΕ ΤΗΝ ΠΑΡΟΥΣΑ</b> Dell Inc. <b>ΔΗΛΩΝΕΙ ΟΤΙ</b> HC03U/HCO3UL <b>ΣΥΜΜΟΡΦΩΝΕΤΑΙ ΠΡΟΣ ΤΙΣ ΟΥΣΙΩΔΕΙΣ ΑΠΑΙΤΗΣΕΙΣ ΚΑΙ ΤΙΣ ΛΟΙΠΕΣ ΣΧΕΤΙΚΕΣ ΔΙΑΤΑΞΕΙΣ ΤΗΣ ΟΔΗΓΙΑΣ 1999/5/ΕΚ</b>
Italian	Con la presente Dell Inc. dichiara che questo HC03U/HCO3UL è conforme ai requisiti essenziali ed alle altre disposizioni pertinenti stabilite dalla direttiva 1999/5/CE.
Spanish	Por medio de la presente Dell Inc. declara que el HC03U/HCO3UL cumple con los requisitos esenciales y cualesquiera otras disposiciones aplicables o exigibles de la Directiva 1999/5/CE
Portuguese	Dell Inc. declara que este HC03U/HCO3UL está conforme com os requisitos essenciais e outras disposições da Directiva 1999/5/CE.

## France

Some areas of France have a restricted frequency band. The worst case maximum authorized power indoors is:

10 mW for the entire 2.4 GHz band (2400 MHz–2483.5 MHz)

100 mW for frequencies between 2446.5 MHz and 2483.5 MHz (NOTE—Channels 10 through 13 inclusive operate in the band 2446.6 MHz to 2483.5 MHz)

There are few possibilities for outdoor use: On private property or on the private property of public persons, use is subject to a preliminary authorization procedure by the Ministry of Defence, with maximum authorized power of 100 mW in the 2446.5–2483.5 MHz band. Use outdoors on public property is not permitted.

In the departments listed below, for the entire 2.4 GHz band:

Maximum authorized power indoors is 100 mW

Maximum authorized power outdoors is 10 mW

Departments in which the use of the 2400–2483.5 MHz band is permitted with an EIRP of less than 100 mW indoors and less than 10 mW outdoors:

01	Ain Orientales	36	Indre	66	Pyrénées
02	Aisne	37	Indre et Loire	67	Bas Rhin
03	Allier	41	Loir et Cher	68	Haut Rhin
05	Hautes Alpes	42	Loire	70	Haute Saône
08	Ardennes	45	Loiret	71	Saône et Loire
09	Ariège	50	Manche	75	Paris
11	Aude	55	Meuse	82	Tarn et Garonne
12	Aveyron	58	Nièvre	84	Vaucluse
16	Charente	59	Nord	88	Vosges
24	Dordogne	60	Oise	89	Yonne
25	Doubs	61	Orne	90	Territoire de Belfort
26	Drôme	63	Puy du Dôme	94	Val de Marne
32	Gers	64	Pyrénées Atlantique		

This requirement is likely to change over time, allowing to use your wireless LAN card in more areas within France. Please check with ART for the latest information ([www.art-telecom.fr](http://www.art-telecom.fr)).

**NOTE:** Your Dell Axim X50 transmits less than 100 mW, but more than 10 mW.

Italia A license is required for indoor use. Outdoor use is prohibited.

E' necessaria la concessione ministeriale anche per l'uso interno. Verificare con i rivenditori la procedura da seguire. L'uso per installazione in esterni non e' permessa.

## Japan Standard

STD-T66 (Ver 1.0)

## Canada—Industry Canada (IC)

This device complies with RSS210 of Industry Canada. Operation of the device is subject to the following two conditions:

- This device may not cause harmful interference.
- This device must accept any interference that may cause undesired operation.

## FCC Standard

47 CFR Part 15, Subpart C (Section 15.247). This version is limited to channel 1 to channel 11 by specified firmware controlled in the U.S.A.

## Federal Communications Commission (FCC)

This device complies with Part 15 of the FCC Rules. Operation of the device is subject to the following two conditions:

- This device may not cause harmful interference.
- This device must accept any interference that may cause undesired operation.

**NOTE:** The radiated output power of this Dell Axim X50 device is far below the FCC radio frequency exposure limits. Nevertheless, the Dell Axim X50 device should be used in such a manner that the potential for human contact during normal operation is minimized. To determine the location of the antenna within your computer, check the information posted on the general Dell support site at [support.dell.com](http://support.dell.com).

## Interference Statement

This equipment has been tested and found to comply with the limits for a Class B digital device, pursuant to Part 15 of the FCC Rules. These limits are designed to provide reasonable protection against harmful interference in a residential installation. This equipment generates, uses, and can radiate radio frequency energy. If the equipment is not installed and used in accordance with the instructions, the equipment may cause harmful interference to radio communications. There is no guarantee, however, that such interference will not occur in a particular installation. If this equipment does cause harmful interference to radio or television reception (which can be determined by turning the equipment off and on), the user is encouraged to try to correct the interference by taking one or more of the following measures:

- Reorient or relocate the receiving antenna.
- Increase the distance between the equipment and the receiver.
- Connect the equipment to an outlet on a circuit different from that to which the receiver is connected.
- Consult the dealer or an experienced radio/TV technician for help.

**NOTE:** This Dell Axim X50 device must be installed and used in strict accordance with the manufacturer's instructions as described in the user documentation that comes with the product. Any other installation or use will violate FCC Part 15 regulations.

**NOTE:** FCC Radiation Exposure Statement:

This equipment complies with FCC RF radiation exposure limits set forth for an uncontrolled environment. End users must follow the specific operating instructions for satisfying RF exposure compliance. This device has been tested and demonstrated compliance when Bluetooth wireless technology and WLAN are transmitting simultaneously. This device must not be co-located or operating in conjunction with any other antenna or transmitter

## **Mexico**

MEC SCT RCPUSCF02-609

## **Singapore—Approved by IDA for Use in Singapore**

DA102617

## **Korea**



R-LARN-03-0166

## Brazil



Este equipamento opera em caráter secundário, isto é não tem direito a proteção contra interferência prejudicial, mesmo de estações do mesmo tipo, e não causar interferência a sistema operando em caráter primário.

## Radio Approvals

To determine whether you are allowed to use your wireless network device in a specific country, please check to see if the radio type number that is printed on the identification label of your device is listed on the radio approval list posted on the general Dell support site at [support.dell.com](http://support.dell.com).

## Contacting Dell

To contact Dell™ electronically, you can access the following websites:

- [www.dell.com](http://www.dell.com)
- [support.dell.com](http://support.dell.com) (technical support)
- [premiersupport.dell.com](http://premiersupport.dell.com) (technical support for educational, government, healthcare, and medium/large business customers, including Premier, Platinum, and Gold customers)

For specific web addresses for your country, find the appropriate country section in the table below.

**NOTE:** Toll-free numbers are for use within the country for which they are listed.

When you need to contact Dell, use the electronic addresses, telephone numbers, and codes provided in the following table. If you need assistance in determining which codes to use, contact a local or an international operator.

<b>Country (City) International Access Code Country Code City Code</b>	<b>Department Name or Service Area, Website and E-Mail Address</b>	<b>Area Codes, Local Numbers, and Toll-Free Numbers</b>
Anguilla	General Support	toll-free: 800-335-0031
Antigua and Barbuda	General Support	1-800-805-5924
Argentina (Buenos Aires) International Access Code: 00 Country Code: 54 City Code: 11	Website: <a href="http://www.dell.com.ar">www.dell.com.ar</a> E-mail: us_latin_services@dell.com E-mail for desktop and portable computers: la-techsupport@dell.com E-mail for servers and EMC: la_enterprise@dell.com	Customer Care toll-free: 0-800-444-0730 Tech Support toll-free: 0-800-444-0733 Tech Support Services toll-free: 0-800-444-0724 Sales 0-810-444-3355
Aruba	General Support	toll-free: 800-1578

<b>Country (City) International Access Code Country Code City Code</b>	<b>Department Name or Service Area, Website and E-Mail Address</b>	<b>Area Codes, Local Numbers, and Toll-Free Numbers</b>
Australia (Sydney)	E-mail (Australia): au_tech_support@dell.com	
International Access Code: 0011	E-mail (New Zealand): nz_tech_support@dell.com	
Country Code: 61	Home and Small Business	1-300-655-533
City Code: 2	Government and Business	toll-free: 1-800-633-559
	Preferred Accounts Division (PAD)	toll-free: 1-800-060-889
	Customer Care	toll-free: 1-800-819-339
	Technical Support (portables and desktops)	toll-free: 1-300-655-533
	Technical Support (servers and workstations)	toll-free: 1-800-733-314
	Corporate Sales	toll-free: 1-800-808-385
	Transaction Sales	toll-free: 1-800-808-312
	Fax	toll-free: 1-800-818-341

<b>Country (City) International Access Code Country Code City Code</b>	<b>Department Name or Service Area, Website and E-Mail Address</b>	<b>Area Codes, Local Numbers, and Toll-Free Numbers</b>
Austria (Vienna) International Access Code: 900 Country Code: 43 City Code: 1	Website: <a href="http://support.euro.dell.com">support.euro.dell.com</a>	
	E-mail: tech_support_central_europe @dell.com	
	Home/Small Business Sales	0820 240 530 00
	Home/Small Business Fax	0820 240 530 49
	Home/Small Business Customer Care	0820 240 530 14
	Preferred Accounts/Corporate Customer Care	0820 240 530 16
	Home/Small Business Technical Support	0820 240 530 14
	Preferred Accounts/Corporate Technical Support	0660 8779
Switchboard	0820 240 530 00	
<b>Bahamas</b>	General Support	toll-free: 1-866-278-6818
<b>Barbados</b>	General Support	1-800-534-3066
Belgium (Brussels) International Access Code: 00 Country Code: 32 City Code: 2	Website: <a href="http://support.euro.dell.com">support.euro.dell.com</a>	
	E-mail for French Speaking Customers: <a href="mailto:support.euro.dell.com/be/fr/emaidell/">support.euro.dell.com/be/fr/emaidell/</a>	
	Technical Support	02 481 92 88
	Technical Support Fax	02 481 92 95
	Customer Care	02 713 15 .65
	Corporate Sales	02 481 91 00
	Fax	02 481 92 99
Switchboard	02 481 91 00	



<b>Country (City) International Access Code Country Code City Code</b>	<b>Department Name or Service Area, Website and E-Mail Address</b>	<b>Area Codes, Local Numbers, and Toll-Free Numbers</b>
Bermuda	General Support	1-800-342-0671
Bolivia	General Support	toll-free: 800-10-0238
<b>Brazil</b>	Website: <a href="http://www.dell.com/br">www.dell.com/br</a>	
International Access Code: 00	Customer Support, Technical Support	0800 90 3355
Country Code: 55	Technical Support Fax	51 481 5470
City Code: 51	Customer Care Fax	51 481 5480
	Sales	0800 90 3390
<b>British Virgin Islands</b>	General Support	toll-free: 1-866-278-6820
<b>Brunei</b>	Customer Technical Support (Penang, Malaysia)	604 633 4966
Country Code: 673	Customer Service (Penang, Malaysia)	604 633 4949
	Transaction Sales (Penang, Malaysia)	604 633 4955

<b>Country (City) International Access Code Country Code City Code</b>	<b>Department Name or Service Area, Website and E-Mail Address</b>	<b>Area Codes, Local Numbers, and Toll-Free Numbers</b>
Canada (North York, Ontario)	Online Order Status: <a href="http://www.dell.ca/ostatus">www.dell.ca/ostatus</a>	
International Access Code: 011	AutoTech (automated technical support)	toll-free: 1-800-247-9362
	Customer Care (Home Sales/Small Business)	toll-free: 1-800-847-4096
	Customer Care (med./large business, government)	toll-free: 1-800-326-9463
	Technical Support (Home Sales/Small Business)	toll-free: 1-800-847-4096
	Technical Support (med./large bus., government)	toll-free: 1-800-387-5757
	Sales (Home Sales/Small Business)	toll-free: 1-800-387-5752
	Sales (med./large bus., government)	toll-free: 1-800-387-5755
	Spare Parts Sales & Extended Service Sales	1 866 440 3355
<b>Cayman Islands</b>	General Support	1-800-805-7541
<b>Chile (Santiago)</b> Country Code: 56 City Code: 2	Sales, Customer Support, and Technical Support  Technical Support E-mail: <a href="mailto:cn_support@dell.com">cn_support@dell.com</a>  Customer Care E-mail: <a href="mailto:customer_cn@dell.com">customer_cn@dell.com</a>  Technical Support Fax	toll-free: 1230-020-4823       818 1350  toll-free: 800 858 2969  toll-free: 800 858 0950
	Technical Support (Dimension™ and Inspiron™)	
	Technical Support (OptiPlex™, Latitude™, and Dell Precision™)	

<b>Country (City) International Access Code Country Code City Code</b>	<b>Department Name or Service Area, Website and E-Mail Address</b>	<b>Area Codes, Local Numbers, and Toll-Free Numbers</b>
China (Xiamen) Country Code: 86 City Code: 592	Technical Support website: <a href="http://support.dell.com.cn">support.dell.com.cn</a> Technical Support E-mail: <a href="mailto:cn_support@dell.com">cn_support@dell.com</a> Customer Care E-mail: <a href="mailto:customer_cn@dell.com">customer_cn@dell.com</a>	
	Technical Support Fax	818 1350
	Technical Support (Dimension™ and Inspiron™)	toll-free: 800 858 2969
	Technical Support (OptiPlex™, Latitude™, and Dell Precision™)	toll-free: 800 858 0950
	Technical Support (servers and storage)	toll-free: 800 858 0960
	Technical Support (projectors, PDAs, printers, switches, routers, and so on)	toll-free: 800 858 2920
	Customer Care	toll-free: 800 858 2060
	Customer Care Fax	592 818 1308
	Home and Small Business	toll-free: 800 858 2222
	Preferred Accounts Division	toll-free: 800 858 2557
	Large Corporate Accounts GCP	toll-free: 800 858 2055
	Large Corporate Accounts Key Accounts	toll-free: 800 858 2628
	Large Corporate Accounts North	toll-free: 800 858 2999
	Large Corporate Accounts North Government and Education	toll-free: 800 858 2955

<b>Country (City) International Access Code Country Code City Code</b>	<b>Department Name or Service Area, Website and E-Mail Address</b>	<b>Area Codes, Local Numbers, and Toll-Free Numbers</b>
China (Xiamen) Country Code: 86 City Code: 592	Large Corporate Accounts East Large Corporate Accounts East Government and Education Large Corporate Accounts Queue Team Large Corporate Accounts South Large Corporate Accounts West Large Corporate Accounts Spare Parts	toll-free: 800 858 2020 toll-free: 800 858 2669 toll-free: 800 858 2572 toll-free: 800 858 2355 toll-free: 800 858 2811 toll-free: 800 858 2621
Colombia	General Support	980-9-15-3978
Costa Rica	General Support	0800-012-0435
Czech Republic (Prague) International Access Code: 00 Country Code: 420	Website: support.euro.dell.com E-mail: czech_dell@dell.com Technical Support Customer Care Fax Tech Fax Switchboard	22537 2727 22537 2707 22537 2714 22537 2728 22537 2711

<b>Country (City) International Access Code Country Code City Code</b>	<b>Department Name or Service Area, Website and E-Mail Address</b>	<b>Area Codes, Local Numbers, and Toll-Free Numbers</b>
Denmark (Copenhagen)	Website: support.euro.dell.com	
International Access Code: 00 Country Code: 45	E-mail: http://support.euro.dell.com/dk/ /da/emaildell/	
	Technical Support	7023 0182
	Customer Care (Relational)	7023 0184
	Home/Small Business Customer Care	3287 5505
	Switchboard (Relational)	3287 1200
	Switchboard Fax (Relational)	3287 1201
	Switchboard (Home/Small Business)	3287 5000
	Switchboard Fax (Home/Small Business)	3287 5001
<b>Dominica</b>	General Support	toll-free: 1-866-278-6821
<b>Dominican Republic</b>	General Support	1-800-148-0530
<b>Ecuador</b>	General Support	toll-free: 999-119
<b>El Salvador</b>	General Support	01-899-753-0777
Finland (Helsinki)	Website: support.euro.dell.com	
International Access Code: 990 Country Code: 358 City Code: 9	E-mail: http://support.euro.dell.com/fi/ fi/emaildell/	
	Technical Support	09 253 313 60
	Customer Care	09 253 313 38
	Fax	09 253 313 99
	Switchboard	09 253 313 00

<b>Country (City) International Access Code Country Code City Code</b>	<b>Department Name or Service Area, Website and E-Mail Address</b>	<b>Area Codes, Local Numbers, and Toll-Free Numbers</b>
France (Paris) (Montpellier)	Website: support.euro.dell.com	
International Access Code: 00	E-mail: support.euro.dell.com/fr/fr/ema ildell/	
Country Code: 33		
City Codes: (1) (4)	<b>Home and Small Business</b>	
	Technical Support	0825 387 270
	Customer Care	0825 823 833
	Switchboard	0825 004 700
	Switchboard (calls from outside of France)	04 99 75 40 00
	Sales	0825 004 700
	Fax	0825 004 701
	Fax (calls from outside of France)	04 99 75 40 01
	<b>Corporate</b>	
	Technical Support	0825 004 719
	Customer Care	0825 338 339
	Switchboard	01 55 94 71 00
	Sales	01 55 94 71 00
	Fax	01 55 94 71 01

<b>Country (City) International Access Code Country Code City Code</b>	<b>Department Name or Service Area, Website and E-Mail Address</b>	<b>Area Codes, Local Numbers, and Toll-Free Numbers</b>
Germany (Langen) International Access Code: 00 Country Code: 49 City Code: 6103	Website: support.euro.dell.com	
	E-mail: tech_support_central_europe @dell.com	
	Technical Support	06103 766-7200
	Home/Small Business Customer Care	0180-5-224400
	Global Segment Customer Care	06103 766-9570
	Preferred Accounts Customer Care	06103 766-9420
	Large Accounts Customer Care	06103 766-9560
	Public Accounts Customer Care	06103 766-9555
	Switchboard	06103 766-7000
Greece International Access Code: 00 Country Code: 30	Website: support.euro.dell.com	
	E-mail: support.euro.dell.com/gr/en/em aiddell/	
	Technical Support	00800-44 14 95 18
	Gold Service Technical Support	00800-44 14 00 83
	Switchboard	2108129810
	Gold Service Switchboard	2108129811
	Sales	2108129800
Fax	2108129812	
Grenada	General Support	toll-free: 1-866-540-3355
Guatemala	General Support	1-800-999-0136
Guyana	General Support	toll-free: 1-877-270-4609

<b>Country (City) International Access Code Country Code City Code</b>	<b>Department Name or Service Area, Website and E-Mail Address</b>	<b>Area Codes, Local Numbers, and Toll-Free Numbers</b>
<b>Hong Kong</b>	Website: <a href="http://support.ap.dell.com">support.ap.dell.com</a>	
International Access Code: 001	Technical Support E-mail: <a href="mailto:apsupport@dell.com">apsupport@dell.com</a>	
Country Code: 852	Technical Support (Dimension and Inspiron)	2969 3188
	Technical Support (OptiPlex, Latitude, and Dell Precision)	2969 3191
	Technical Support (PowerApp™, PowerEdge™, PowerConnect™, and PowerVault™)	2969 3196
	Customer Care	3416 0910
	Large Corporate Accounts	3416 0907
	Global Customer Programs	3416 0908
	Medium Business Division	3416 0912
	Home and Small Business Division	2969 3105
<b>India</b>	Technical Support	1600 33 8045
	Sales (Large Corporate Accounts)	1600 33 8044
	Sales (Home and Small Business )	1600 33 8046



<b>Country (City) International Access Code Country Code City Code</b>	<b>Department Name or Service Area, Website and E-Mail Address</b>	<b>Area Codes, Local Numbers, and Toll-Free Numbers</b>
Ireland (Cherrywood)	Website: support.euro.dell.com	
International Access Code: 16	E-mail: dell_direct_support@dell.com	
Country Code: 353	Technical Support	1850 543 543
City Code: 1	U.K. Technical Support (dial within U.K. only)	0870 908 0800
	Home User Customer Care	01 204 4014
	Small Business Customer Care	01 204 4014
	U.K. Customer Care (dial within U.K. only)	0870 906 0010
	Corporate Customer Care	1850 200 982
	Corporate Customer Care (dial within U.K. only)	0870 907 4499
	Ireland Sales	01 204 4444
	U.K. Sales (dial within U.K. only)	0870 907 4000
	Fax/Sales Fax	01 204 0103
	Switchboard	01 204 4444

<b>Country (City) International Access Code Country Code City Code</b>	<b>Department Name or Service Area, Website and E-Mail Address</b>	<b>Area Codes, Local Numbers, and Toll-Free Numbers</b>
<b>Italy (Milan)</b> International Access Code: <b>00</b> Country Code: <b>39</b> City Code: <b>02</b>	Website: <a href="http://support.euro.dell.com">support.euro.dell.com</a>	
	E-mail: <a href="mailto:support.euro.dell.com/it/emailldell/">support.euro.dell.com/it/emailldell/</a>	
	<b>Home and Small Business</b>	
	Technical Support	02 577 826 90
	Customer Care	02 696 821 14
	Fax	02 696 821 13
	Switchboard	02 696 821 12
	<b>Corporate</b>	
	Technical Support	02 577 826 90
	Customer Care	02 577 825 55
Fax	02 575 035 30	
Switchboard	02 577 821	
<b>Jamaica</b>	General Support (dial from within Jamaica only)	1-800-682-3639
<b>Japan (Kawasaki)</b> International Access Code: <b>001</b> Country Code: <b>81</b> City Code: <b>44</b>	Website: <a href="http://support.jp.dell.com">support.jp.dell.com</a>	
	Technical Support (servers)	toll-free: 0120-198-498
	Technical Support outside of Japan (servers)	81-44-556-4162
	Technical Support (Dimension and Inspiron)	toll-free: 0120-198-226
	Technical Support outside of Japan (Dimension and Inspiron)	81-44-520-1435

<b>Country (City) International Access Code Country Code City Code</b>	<b>Department Name or Service Area, Website and E-Mail Address</b>	<b>Area Codes, Local Numbers, and Toll-Free Numbers</b>
Japan (Kawasaki) International Access Code: 001 Country Code: 81 City Code: 44	Technical Support (Dell Precision, OptiPlex, and Latitude)	toll-free:0120-198-433
	Technical Support outside of Japan (Dell Precision, OptiPlex, and Latitude)	81-44-556-3894
	Technical Support (PDAs, projectors, printers, routers)	toll-free: 0120-981-690
	Technical Support outside of Japan (PDAs, projectors, printers, routers)	81-44-556-3468
	Faxbox Service	044-556-3490
	24-Hour Automated Order Service	044-556-3801
	Customer Care	044-556-4240
	Business Sales Division (up to 400 employees)	044-556-1465
	Preferred Accounts Division Sales (over 400 employees)	044-556-3433
	Large Corporate Accounts Sales (over 3500 employees)	044-556-3430
	Public Sales (government agencies, educational institutions, and medical institutions)	044-556-1469
	Global Segment Japan	044-556-3469
	Individual User	044-556-1760
	Switchboard	044-556-4300

<b>Country (City) International Access Code Country Code City Code</b>	<b>Department Name or Service Area, Website and E-Mail Address</b>	<b>Area Codes, Local Numbers, and Toll-Free Numbers</b>
Korea (Seoul) International Access Code: 001 Country Code: 82 City Code: 2	Technical Support	toll-free: 080-200-3800
	Sales	toll-free: 080-200-3600
	Customer Service (Penang, Malaysia)	604 633 4949
	Fax	2194-6202
	Switchboard	2194-6000
	Technical Support (Electronics and Accessories)	toll-free: 080-200-3801
Latin America	Customer Technical Support (Austin, Texas, U.S.A.)	512 728-4093
	Customer Service (Austin, Texas, U.S.A.)	512 728-3619
	Fax (Technical Support and Customer Service) (Austin, Texas, U.S.A.)	512 728-3883
	Sales (Austin, Texas, U.S.A.)	512 728-4397
	SalesFax (Austin, Texas, U.S.A.)	512 728-4600 or 512 728-3772

<b>Country (City) International Access Code Country Code City Code</b>	<b>Department Name or Service Area, Website and E-Mail Address</b>	<b>Area Codes, Local Numbers, and Toll-Free Numbers</b>
Luxembourg International Access Code: 00 Country Code: 352	Website: support.euro.dell.com E-mail: tech_be@dell.com Technical Support (Brussels, Belgium) Home/Small Business Sales (Brussels, Belgium) Corporate Sales (Brussels, Belgium) Customer Care (Brussels, Belgium) Fax (Brussels, Belgium) Switchboard (Brussels, Belgium)	3420808075 toll-free: 080016884 02 481 91 00 02 481 91 19 02 481 92 99 02 481 91 00
Macao Country Code: 853	Technical Support Customer Service (Xiamen, China) Transaction Sales (Xiamen, China)	toll-free: 0800 105 34 160 910 29 693 115

<b>Country (City) International Access Code Country Code City Code</b>	<b>Department Name or Service Area, Website and E-Mail Address</b>	<b>Area Codes, Local Numbers, and Toll-Free Numbers</b>
Malaysia (Penang)	Website: support.ap.dell.com	toll-free: 1 800 88 0193
International Access Code: 00 Country Code: 60 City Code: 4	Technical Support (Dell Precision, OptiPlex, and Latitude)	toll-free: 1 800 88 1306
	Technical Support (Dimension, Inspiron, and Electronics and Accessories)	
	Technical Support (PowerApp, PowerEdge, PowerConnect, and PowerVault)	toll-free: 1800 88 1386
	Customer Service (Penang, Malaysia)	04 633 4949
	Transaction Sales	toll-free: 1 800 888 202
	Corporate Sales	toll-free: 1 800 888 213
Mexico	Customer Technical Support	001-877-384-8979
International Access Code: 00		or 001-877-269-3383
Country Code: 52	Sales	50-81-8800
		or 01-800-888-3355
	Customer Service	001-877-384-8979
		or 001-877-269-3383
	Main	50-81-8800
		or 01-800-888-3355
Montserrat	General Support	toll-free: 1-866-278-6822
Netherlands Antilles	General Support	001-800-882-1519

<b>Country (City) International Access Code Country Code City Code</b>	<b>Department Name or Service Area, Website and E-Mail Address</b>	<b>Area Codes, Local Numbers, and Toll-Free Numbers</b>
Netherlands (Amsterdam)	Website: support.euro.dell.com	
International Access Code: 00	Technical Support	020 674 45 00
Country Code: 31	Technical Support Fax	020 674 47 66
City Code: 20	Home/Small Business Customer Care	020 674 42 00
	Relational Customer Care	020 674 4325
	Home/Small Business Sales	020 674 55 00
	Relational Sales	020 674 50 00
	Home/Small Business Sales Fax	020 674 47 75
	Relational Sales Fax	020 674 47 50
	Switchboard	020 674 50 00
	Switchboard Fax	020 674 47 50
<b>New Zealand</b>	E-mail (New Zealand): nz_tech_support@dell.com	
International Access Code: 00	E-mail (Australia): au_tech_support@dell.com	
Country Code: 64	Technical Support (for desktop and portable computers)	toll-free: 0800 446 255
	Technical Support (for servers and workstations)	toll-free: 0800 443 563
	Home and Small Business	0800 446 255
	Government and Business	0800 444 617
	Sales	0800 441 567
	Fax	0800 441 566
Nicaragua	General Support	001-800-220-1006

<b>Country (City) International Access Code Country Code City Code</b>	<b>Department Name or Service Area, Website and E-Mail Address</b>	<b>Area Codes, Local Numbers, and Toll-Free Numbers</b>
Norway (Lysaker) International Access Code: 00 Country Code: 47	Website: <a href="http://support.euro.dell.com">support.euro.dell.com</a> E-mail: <a href="http://support.euro.dell.com/no/no/emaildell/">http://support.euro.dell.com/no/no/emaildell/</a>	
	Technical Support	671 16882
	Relational Customer Care	671 17575
	Home/Small Business Customer Care	23162298
	Switchboard	671 16800
	Fax Switchboard	671 16865
Panama	General Support	001-800-507-0962
Peru	General Support	0800-50-669
Poland (Warsaw) International Access Code: 011 Country Code: 48 City Code: 22	Website: <a href="http://support.euro.dell.com">support.euro.dell.com</a> E-mail: <a href="mailto:pl_support_tech@dell.com">pl_support_tech@dell.com</a>	
	Customer Service Phone	57 95 700
	Customer Care	57 95 999
	Sales	57 95 999
	Customer Service Fax	57 95 806
	Reception Desk Fax	57 95 998
	Switchboard	57 95 999



<b>Country (City) International Access Code Country Code City Code</b>	<b>Department Name or Service Area, Website and E-Mail Address</b>	<b>Area Codes, Local Numbers, and Toll-Free Numbers</b>
Portugal International Access Code: 00 Country Code: 351	Website: support.euro.dell.com E-mail: support.euro.dell.com/pt/en/e maildell/ Technical Support Customer Care Sales Fax	707200149 800 300 413 800 300 410 or 800 300 411 or 800 300 412 or 21 422 07 10 21 424 01 12
Puerto Rico	General Support	1-800-805-7545
St. Kitts and Nevis	General Support	toll-free: 1-877-441-4731
St. Lucia	General Support	1-800-882-1521
St. Vincent and the Grenadines	General Support	toll-free: 1-877-270-4609
Singapore (Singapore) International Access Code: 005 Country Code: 65	Website: support.ap.dell.com Technical Support (Dimension, Inspiron, and Electronics and Accessories) Technical Support (OptiPlex, Latitude, and Dell Precision) Technical Support (PowerApp, PowerEdge, PowerConnect, and PowerVault) Customer Service (Penang, Malaysia) Transaction Sales Corporate Sales	toll-free: 1800 394 7430 toll-free: 1800 394 7488 toll-free: 1800 394 7478 604 633 4949 toll-free: 1 800 394 7412 toll-free: 1 800 394 7419

<b>Country (City) International Access Code Country Code City Code</b>	<b>Department Name or Service Area, Website and E-Mail Address</b>	<b>Area Codes, Local Numbers, and Toll-Free Numbers</b>
Slovakia (Prague) International Access Code: 00 Country Code: 421	Website: support.euro.dell.com	
	E-mail: czech_dell@dell.com	
	Technical Support	02 5441 5727
	Customer Care	420 22537 2707
	Fax	02 5441 8328
	Tech Fax	02 5441 8328
	Switchboard (Sales)	02 5441 7585
South Africa (Johannesburg) International Access Code: 09/091 Country Code: 27 City Code: 11	Website: support.euro.dell.com	
	E-mail: dell_za_support@dell.com	
	Gold Queue	011 709 7713
	Technical Support	011 709 7710
	Customer Care	011 709 7707
	Sales	011 709 7700
	Fax	011 706 0495
	Switchboard	011 709 7700
Southeast Asian and Pacific Countries	Customer Technical Support, Customer Service, and Sales (Penang, Malaysia)	604 633 4810

<b>Country (City) International Access Code Country Code City Code</b>	<b>Department Name or Service Area, Website and E-Mail Address</b>	<b>Area Codes, Local Numbers, and Toll-Free Numbers</b>
Spain (Madrid) International Access Code: 00 Country Code: 34 City Code: 91	Website: support.euro.dell.com	
	E-mail: support.euro.dell.com/es/es/ emaildell/	
	<b>Home and Small Business</b>	
	Technical Support	902 100 130
	Customer Care	902 118 540
	Sales	902 118 541
	Switchboard	902 118 541
	Fax	902 118 539
	<b>Corporate</b>	
	Technical Support	902 100 130
	Customer Care	902 115 236
	Switchboard	91 722 92 00
	Fax	91 722 95 83
	Sweden (Upplands Vasby) International Access Code: 00 Country Code: 46 City Code: 8	Website: support.euro.dell.com
E-mail: http://support.euro.dell.com/se/ sv/emaildell/		
Technical Support		08 590 05 199
Relational Customer Care		08 590 05 642
Home/Small Business Customer Care		08 587 70 527
Employee Purchase Program (EPP) Support		20 140 14 44
Technical Support Fax		08 590 05 594
Sales		08 590 05 185

<b>Country (City) International Access Code Country Code City Code</b>	<b>Department Name or Service Area, Website and E-Mail Address</b>	<b>Area Codes, Local Numbers, and Toll-Free Numbers</b>
Switzerland (Geneva) International Access Code: 00 Country Code: 41 City Code: 22	Website: support.euro.dell.com  E-mail: Tech_support_central_Europe @dell.com  E-mail for French-speaking HSB and Corporate Customers: support.euro.dell.com/ch/fr/e maildell/	
	Technical Support (Home and Small Business)	0844 811 411
	Technical Support (Corporate)	0844 822 844
	Customer Care (Home and Small Business)	0848 802 202
	Customer Care (Corporate)	0848 821 721
	Fax	022 799 01 90
	Switchboard	022 799 01 01
<b>Taiwan</b>	Website: support.ap.dell.com	
International Access Code: 002 Country Code: 886	E-mail: ap_support@dell.com  Technical Support (OptiPlex, Latitude, Inspiron, Dimension, and Electronics and Accessories)	toll-free: 00801 86 1011
	Technical Support (PowerApp, PowerEdge, PowerConnect, and PowerVault)	toll-free: 00801 60 1256
	Transaction Sales	toll-free: 00801 65 1228
	Corporate Sales	toll-free: 00801 651 227

<b>Country (City) International Access Code Country Code City Code</b>	<b>Department Name or Service Area, Website and E-Mail Address</b>	<b>Area Codes, Local Numbers, and Toll-Free Numbers</b>
Thailand	Website: <a href="http://support.ap.dell.com">support.ap.dell.com</a>	
International Access Code: 001	Technical Support (OptiPlex, Latitude, and Dell Precision)	toll-free: 1800 0060 07
Country Code: 66	Technical Support (PowerApp, PowerEdge, PowerConnect, and PowerVault)	toll-free: 1800 0600 09
	Customer Service (Penang, Malaysia)	604 633 4949
	Corporate Sales	toll-free: 1800 006 009
	Transaction Sales	toll-free: 1800 006 006
Trinidad/Tobago	General Support	1-800-805-8035
Turks and Caicos Islands	General Support	toll-free: 1-866-540-3355

<b>Country (City) International Access Code Country Code City Code</b>	<b>Department Name or Service Area, Website and E-Mail Address</b>	<b>Area Codes, Local Numbers, and Toll-Free Numbers</b>
U.K. (Bracknell) International Access Code: 00 Country Code: 44 City Code: 1344	Website: <a href="http://support.euro.dell.com">support.euro.dell.com</a> Customer Care website: <a href="http://support.euro.dell.com/uk/en/ECare/Form/Home.asp">support.euro.dell.com/uk/en/ECare/Form/Home.asp</a>  E-mail: <a href="mailto:dell_direct_support@dell.com">dell_direct_support@dell.com</a>	
	Technical Support (Corporate/Preferred Accounts/PAD [1000+ employees])	0870 908 0500
	Technical Support (direct and general)	0870 908 0800
	Global Accounts Customer Care	01344 373 186
	Home and Small Business Customer Care	0870 906 0010
	Corporate Customer Care	01344 373 185
	Preferred Accounts (500–5000 employees) Customer Care	0870 906 0010
	Central Government Customer Care	01344 373 193
	Local Government & Education Customer Care	01344 373 199
	Health Customer Care	01344 373 194
	Home and Small Business Sales	0870 907 4000
	Corporate/Public Sector Sales	01344 860 456
	Home and Small Business Fax	0870 907 4006
<b>Uruguay</b>	General Support	toll-free: 000-413-598-2521

<b>Country (City) International Access Code Country Code City Code</b>	<b>Department Name or Service Area, Website and E-Mail Address</b>	<b>Area Codes, Local Numbers, and Toll-Free Numbers</b>
U.S.A. (Austin, Texas)	Automated Order-Status Service	toll-free: 1-800-433-9014
International Access Code: 011	AutoTech (portable and desktop computers)	toll-free: 1-800-247-9362
Country Code: 1	<b>Consumer</b> (Home and Home Office)	
	Technical Support	toll-free: 1-800-624-9896
	Customer Service	toll-free: 1-800-624-9897
	DellNet™ Service and Support	toll-free: 1-877-Dellnet (1-877-335-5638)
	Employee Purchase Program (EPP) Customers	toll-free: 1-800-695-8133
	Financial Services website: <a href="http://www.dellfinancialservices.com">www.dellfinancialservices.com</a>	
	Financial Services (lease/loans)	toll-free: 1-877-577-3355
	Financial Services (Dell Preferred Accounts [DPA])	toll-free: 1-800-283-2210
	<b>Business</b>	
	Customer Service and Technical Support	toll-free: 1-800-822-8965
	Employee Purchase Program (EPP) Customers	toll-free: 1-800-695-8133
	Printers and Projectors Technical Support	toll-free: 1-877-459-7298

<b>Country (City) International Access Code Country Code City Code</b>	<b>Department Name or Service Area, Website and E-Mail Address</b>	<b>Area Codes, Local Numbers, and Toll-Free Numbers</b>
	Public (government, education, and healthcare)	
	Customer Service and Technical Support	toll-free: 1-800-456-3355
	Employee Purchase Program (EPP) Customers	toll-free: 1-800-234-1490
	Dell Sales	toll-free: 1-800-289-3355 or toll-free: 1-800-879-3355
	Dell Outlet Store (Dell refurbished computers)	toll-free: 1-888-798-7561
	Software and Peripherals Sales	toll-free: 1-800-671-3355
	Spare Parts Sales	toll-free: 1-800-357-3355
	Extended Service and Warranty Sales	toll-free: 1-800-247-4618
	Fax	toll-free: 1-800-727-8320
	Dell Services for the Deaf, Hard-of-Hearing, or Speech-Impaired	toll-free: 1-877-DELLTTY (1-877-335-5889)
<b>U.S. Virgin Islands</b>	General Support	1-877-673-3355
<b>Venezuela</b>	General Support	8001-3605



# Limited Warranties

Dell-branded hardware products purchased in the U.S. or Canada come with either a 90-day, 1-year, 2-year, 3-year, or 4-year limited warranty, depending on the product purchased. To determine which warranty came with your hardware product(s), see your packing slip or invoice. The following sections describe the limited warranties and return policy for the U.S., the limited warranties and return policy for Canada, the manufacturer guarantee for Latin America and the Caribbean, and the Intel® Pentium® and Celeron® warranty for the U.S. and Canada.

## Limited Warranty for Dell-Branded Hardware Products (U.S. Only)

### What is covered by this limited warranty?

This limited warranty covers defects in materials and workmanship in your—our end-user customer's—Dell-branded hardware products, including Dell-branded peripheral products.

### What is not covered by this limited warranty?

This limited warranty does not cover:

- Software, including the operating system and software added to the Dell-branded hardware products through our factory-integration system, third-party software, or the reloading of software
- Non-Dell-branded and Solution Provider Direct products and accessories
- Problems that result from:
  - External causes such as accident, abuse, misuse, or problems with electrical power
  - Servicing not authorized by Dell
  - Usage that is not in accordance with product instructions
  - Failure to follow the product instructions or failure to perform preventive maintenance
  - Problems caused by using accessories, parts, or components not supplied by Dell
- Products with missing or altered Service Tags or serial numbers
- Products for which Dell has not received payment

THIS WARRANTY GIVES YOU SPECIFIC LEGAL RIGHTS, AND YOU MAY ALSO HAVE OTHER RIGHTS WHICH VARY FROM STATE TO STATE (OR JURISDICTION TO JURISDICTION). DELL'S RESPONSIBILITY FOR MALFUNCTIONS AND DEFECTS IN HARDWARE IS LIMITED TO REPAIR AND REPLACEMENT AS SET FORTH IN THIS WARRANTY STATEMENT. ALL EXPRESS AND IMPLIED WARRANTIES FOR THE PRODUCT, INCLUDING BUT NOT LIMITED TO ANY IMPLIED WARRANTIES AND CONDITIONS OF MERCHANTABILITY AND FITNESS FOR A PARTICULAR PURPOSE, ARE LIMITED IN TIME TO THE TERM OF THE LIMITED WARRANTY PERIOD REFLECTED ON YOUR PACKING SLIP OR INVOICE. NO WARRANTIES, WHETHER EXPRESS OR IMPLIED, WILL APPLY AFTER THE LIMITED WARRANTY PERIOD HAS EXPIRED. SOME STATES DO NOT ALLOW LIMITATIONS ON HOW LONG AN IMPLIED WARRANTY LASTS, SO THIS LIMITATION MAY NOT APPLY TO YOU.

WE DO NOT ACCEPT LIABILITY BEYOND THE REMEDIES PROVIDED FOR IN THIS LIMITED WARRANTY OR FOR CONSEQUENTIAL OR INCIDENTAL DAMAGES, INCLUDING, WITHOUT LIMITATION, ANY LIABILITY FOR THIRD-PARTY CLAIMS AGAINST YOU FOR DAMAGES, FOR PRODUCTS NOT BEING AVAILABLE FOR USE, OR FOR LOST DATA OR LOST SOFTWARE. OUR LIABILITY WILL BE NO MORE THAN THE AMOUNT YOU PAID FOR THE PRODUCT THAT IS THE SUBJECT OF A CLAIM. THIS IS THE MAXIMUM AMOUNT FOR WHICH WE ARE RESPONSIBLE.

SOME STATES DO NOT ALLOW THE EXCLUSION OR LIMITATION OF INCIDENTAL OR CONSEQUENTIAL DAMAGES, SO THE ABOVE LIMITATION OR EXCLUSION MAY NOT APPLY TO YOU.

### **How long does this limited warranty last?**

This limited warranty lasts for the time period indicated on your packing slip or invoice, except for the following Dell-branded hardware:

- Portable computer batteries carry a 1-year limited warranty.
- Projector lamps carry a 90-day limited warranty.
- Memory carries a lifetime limited warranty.
- Monitors carry the longer of either a 3-year limited warranty or the remainder of the warranty for the Dell computer to which the monitor will be connected.
- "PDAs, MP3 players, earphones, remote inline controls, and AC adapters carry a 1-year limited warranty.
- Other add-on hardware carries the longer of either a 1-year limited warranty for new parts and a 90-day limited warranty for reconditioned parts or, for both new and reconditioned parts, the remainder of the warranty for the Dell computer on which such parts are installed.

The limited warranty on all Dell-branded products begins on the date of the packing slip or invoice. The warranty period is not extended if we repair or replace a warranted product or any parts. Dell may change the availability of limited warranties, at its discretion, but any changes will not be retroactive.

## What do I do if I need warranty service?

Before the warranty expires, please call us at the relevant number listed in the following table. Please also have your Dell Service Tag or order number available.

<b>Individual Home Consumers:</b>	<b>U.S. Only</b>
Technical Support	1-800-624-9896
Customer Service	1-800-624-9897
<b>Individual Home Consumers who purchased through an Employee Purchase Program:</b>	
Technical Support and Customer Service	1-800-822-8965
<b>Home and Small Business Commercial Customers:</b>	
Technical Support and Customer Service	1-800-456-3355
<b>Medium, Large, or Global Commercial Customers, Healthcare Customers, and Value-Added Resellers (VARs):</b>	
Technical Support and Customer Service	1-800-822-8965
<b>Government and Education Customers:</b>	
Technical Support and Customer Service	1-800-234-1490
<b>Dell-Branded Memory</b>	1-888-363-5150

## What will Dell do?

**During the 90 days of the 90-day limited warranty and the first year of all other limited warranties:** During the 90 days of the 90-day limited warranty and the first year of all other limited warranties, we will repair any Dell-branded hardware products returned to us that prove to be defective in materials or workmanship. If we are not able to repair the product, we will replace it with a comparable product that is new or refurbished.

When you contact us, we will issue a Return Material Authorization Number for you to include with your return. You must return the products to us in their original or equivalent packaging, prepay shipping charges, and insure the shipment or accept the risk if the product is lost or damaged in shipment. We will return the repaired or replacement products to you. We will pay to ship the repaired or replaced products to you if you use an address in the United States (excluding Puerto Rico and U.S. possessions and territories). Otherwise, we will ship the product to you freight collect.

If we determine that the product is not covered under this warranty, we will notify you and inform you of service alternatives that are available to you on a fee basis.

**NOTE:** Before you ship the product(s) to us, make sure to back up the data on the hard drive(s) and any other storage device(s) in the product(s). Remove any confidential, proprietary, or personal information and removable media such as floppy disks, CDs, or PC Cards. We are not responsible for any of your confidential, proprietary, or personal information; lost or corrupted data; or damaged or lost removable media.

**During the remaining years:** For the remaining period of the limited warranty, we will replace any defective part with new or refurbished parts, if we agree that it needs to be replaced. When you contact us, we will require a valid credit card number at the time you request a replacement part, but we will not charge you for the replacement part as long as you return the original part to us within 30 days after we ship the replacement part to you. If we do not receive the original part within 30 days, we will charge to your credit card the then-current standard price for that part.

We will pay to ship the part to you if you use an address in the United States (excluding Puerto Rico and U.S. possessions and territories). Otherwise, we will ship the part freight collect. We will also include a prepaid shipping container with each replacement part for your use in returning the replaced part to us.

**NOTE:** Before you replace parts, make sure to back up the data on the hard drive(s) and any other storage device(s) in the product(s). We are not responsible for lost or corrupted data.

## What if I purchased a service contract?

If your service contract is with Dell, service will be provided to you under the terms of the service agreement. Please refer to that contract for details on how to obtain service.

If you purchased through us a service contract with one of our third-party service providers, please refer to that contract for details on how to obtain service.

## How will you fix my product?

We use new and refurbished parts made by various manufacturers in performing warranty repairs and in building replacement parts and systems. Refurbished parts and systems are parts or systems that have been returned to Dell, some of which were never used by a customer. All parts and systems are inspected and tested for quality. Replacement parts and systems are covered for the remaining period of the limited warranty for the product you bought. Dell owns all parts removed from repaired products.

## May I transfer the limited warranty?

Limited warranties on systems may be transferred if the current owner transfers ownership of the system and records the transfer with us. The limited warranty on Dell-branded memory may not be transferred. You may record your transfer by going to Dell's website:

- If you are an Individual Home Consumer, go to [www.dell.com/us/en/dhs/topics/sbtopic\\_015\\_ccare.htm](http://www.dell.com/us/en/dhs/topics/sbtopic_015_ccare.htm)
- If you are a Home Office, Small, Medium, Large, or Global Commercial Customer, go to [www.dell.com/us/en/biz/topics/sbtopic\\_ccare\\_nav\\_015\\_ccare.htm](http://www.dell.com/us/en/biz/topics/sbtopic_ccare_nav_015_ccare.htm)
- If you are a Government, Education, or Healthcare Customer, or an Individual Home Consumer who purchased through an Employee Purchase Program, go to [www.dell.com/us/en/pub/topics/sbtopic\\_015\\_ccare.htm](http://www.dell.com/us/en/pub/topics/sbtopic_015_ccare.htm)

If you do not have Internet access, call your customer care representative or call 1-800-624-9897.

## Total Satisfaction Return Policy (U.S. Only)

We value our relationship with you and want to make sure that you're satisfied with your purchases. That's why we offer a "Total Satisfaction" return policy for most products that you—the end-user customer—purchase directly from Dell. Under this policy, you may return to Dell products that you purchased directly from Dell for a credit or a refund of the purchase price paid, less shipping and handling and applicable return fees as follows:

**New Hardware Products and Accessories:** Unless you have a separate agreement with Dell, all hardware, accessories, peripherals, parts and unopened software still in its/their sealed package, excluding the products listed below, may be returned within twenty-one (21) days from the date on the packing slip or invoice.

Exclusions from the foregoing return policy:

- New PowerEdge™, PowerConnect™, and PowerVault™ products (excluding PowerVault 160T tape libraries) may be returned within thirty (30) days from the date on the packing slip or invoice, except that new PowerEdge™ SC servers and n series products purchased from the Small and Medium Business Sales Division may only be returned within fourteen (14) days from the date on the packing slip or invoice.
- Application software or an operating system that has been installed by Dell may not be returned unless you return the entire computer under the 21-day return policy, if applicable to your purchase (if not applicable to your purchase, you may not return application software or an operating system).

- Non-defective third party and Dell-branded software, peripheral, electronics and accessory products (for example: televisions, printers, projectors, MP3 players, PDAs, battery chargers, non-preinstalled third party software, wireless cards/access points/routers), including but not limited to those sold by or through Dell's "Software & Peripherals" or "Electronics & Accessories" groups, may be returned within twenty-one (21) days from the date on the packing slip or invoice, but a fifteen percent (15%) return fee may be deducted from any refund or credit.
- Dell | EMC storage products, EMC-branded products, Unisys-branded products, PowerVault™ 160T tape libraries, enterprise software, non-Dell branded enterprise products, software and/or software licenses, or any non-Dell customized hardware and/or software product(s) may not be returned at any time.

**Reconditioned or Refurbished Dell-Branded Hardware Products and Parts** — All reconditioned or refurbished PowerEdge™, PowerConnect™, and PowerVault™ products may be returned within 30 days from the date on the packing slip or invoice. All other reconditioned or refurbished Dell-branded hardware products and parts may be returned within 14 days of the date on the packing slip or invoice.

**How to Return** — To return products, e-mail or call Dell customer service to receive a Credit Return Authorization Number within the return policy period applicable to the product you want to return. You must obtain a Credit Return Authorization Number in order to return the product. See "Contacting Dell" or "Getting Help" in your customer documentation (or [www.dell.com/us/en/gen/contact.htm](http://www.dell.com/us/en/gen/contact.htm)) to find the appropriate contact information for obtaining customer assistance.

You must ship the products to Dell within 5 days of the date that Dell issues the Credit Return Authorization Number. You must also return the products to Dell in their original packaging, in as-new condition along with any media, documentation, and all other items that were included in the original shipment, prepay shipping charges, and insure the shipment or accept the risk of loss or damage during shipment.

**NOTE:** Before you ship the product(s) to us, make sure to back up the data on the hard drive(s) and any other storage device(s) in the product(s). Remove any confidential, proprietary, or personal information and removable media such as floppy disks, CDs, or PC Cards. We are not responsible for any of your confidential, proprietary, or personal information; lost or corrupted data; or damaged or lost removable media.

## Limited Warranty Terms for Dell-Branded Hardware Products (Canada Only)

### What is covered by this limited warranty?

This limited warranty covers defects in materials and workmanship in your—our end-user customer's—Dell-branded hardware products, including Dell-branded peripheral products.

## What is not covered by this limited warranty?

This limited warranty does not cover:

- Software, including the operating system and software added to the Dell-branded hardware products through our factory-integration system, or the reloading of the software
- Non-Dell branded and Solution Provider Direct products and accessories
- Problems that result from:
  - External causes such as accident, abuse, misuse, or problems with electrical power
  - Servicing not authorized by Dell
  - Usage that is not in accordance with product instructions
  - Failure to follow the product instructions or failure to perform preventive maintenance
  - Problems caused by using accessories, parts, or components not supplied by Dell
- Products with missing or altered Service Tags or serial numbers
- Products for which Dell has not received payment

THIS WARRANTY GIVES YOU SPECIFIC LEGAL RIGHTS, AND YOU MAY ALSO HAVE OTHER RIGHTS WHICH VARY FROM PROVINCE TO PROVINCE. DELL'S RESPONSIBILITY FOR MALFUNCTIONS AND DEFECTS IN PRODUCT IS LIMITED TO REPAIR AND REPLACEMENT AS SET FORTH IN THIS WARRANTY STATEMENT, FOR THE TERM OF THE WARRANTY PERIOD REFLECTED ON YOUR PACKING SLIP OR INVOICE. EXCEPT FOR THE EXPRESS WARRANTIES CONTAINED IN THIS WARRANTY STATEMENT, DELL DISCLAIMS ALL OTHER WARRANTIES AND CONDITIONS, EXPRESS OR IMPLIED, INCLUDING WITHOUT LIMITATION IMPLIED WARRANTIES AND CONDITIONS OF MERCHANTABILITY AND FITNESS FOR A PARTICULAR PURPOSE, STATUTORY OR OTHERWISE. SOME PROVINCES DO NOT ALLOW THE EXCLUSION OF CERTAIN IMPLIED WARRANTIES OR CONDITIONS, OR LIMITATIONS ON HOW LONG AN IMPLIED WARRANTY OR CONDITION LASTS. THEREFORE, THE FOREGOING EXCLUSIONS AND LIMITATIONS MAY NOT APPLY TO YOU.

WE DO NOT ACCEPT LIABILITY BEYOND THE REMEDIES PROVIDED FOR IN THIS WARRANTY STATEMENT OR FOR SPECIAL, INDIRECT, CONSEQUENTIAL, OR INCIDENTAL DAMAGES, INCLUDING, WITHOUT LIMITATION, ANY LIABILITY FOR THIRD-PARTY CLAIMS AGAINST YOU FOR DAMAGES, FOR PRODUCTS NOT BEING AVAILABLE FOR USE, OR FOR LOST DATA OR LOST SOFTWARE. OUR LIABILITY WILL BE NO MORE THAN THE AMOUNT YOU PAID FOR THE PRODUCT THAT IS THE SUBJECT OF A CLAIM. THIS IS THE MAXIMUM AMOUNT FOR WHICH WE ARE RESPONSIBLE.

SOME PROVINCES DO NOT ALLOW THE EXCLUSION OR LIMITATION OF SPECIAL, INDIRECT, INCIDENTAL, OR CONSEQUENTIAL DAMAGES, SO THE ABOVE LIMITATION OR EXCLUSION MAY NOT APPLY TO YOU.

## How long does this limited warranty last?

This limited warranty lasts for the time period indicated on your packing slip or invoice, except that the limited warranty on Dell-branded batteries lasts only 1 year and the limited warranty on the lamps for Dell-branded projectors lasts only 90 days. The limited warranty begins on the date of the packing slip or invoice. The warranty period is not extended if we repair or replace a warranted product or any parts. Dell may change the terms and availability of limited warranties, at its discretion, but any changes will not be retroactive (that is, the warranty terms in place at the time of purchase will apply to your purchase).

## What do I do if I need warranty service?

Before the warranty expires, please call us at the relevant number listed in the following table. Please also have your Dell Service Tag or order number available.

<b>Individual Home Consumers; Home Office and Small Business Customers:</b>	<b>Canada Only</b>
Technical Support and Customer Service	1-800-847-4096
<b>Medium, Large, and Global Commercial Customers; Government, Education, and Healthcare Customers; and Value-Added Resellers (VARs):</b>	
Technical Support	1-800-387-5757
Customer Service	1-800-326-9463
<b>Government or Education Customers, or Individual Home Consumers who purchased through an Employee Purchase Program:</b>	
Technical Support	1-800-387-5757
Customer Service	1-800-326-9463 (Extension 8221 for Individual Consumers)
<b>Dell-Branded Memory</b>	1-888-363-5150

## What will Dell do?

During the 90 days of the 90-day limited warranty and the first year of all other limited warranties: During the 90 days of the 90-day limited warranty and the first year of all other limited warranties, we will repair any Dell-branded hardware products returned to us that prove to be defective in materials or workmanship. If we are not able to repair the product, we will replace it with a comparable product that is new or refurbished.



When you contact us, we will issue a Return Material Authorization Number for you to include with your return. You must return the products to us in their original or equivalent packaging, prepay shipping charges, and insure the shipment or accept the risk if the product is lost or damaged in shipment. We will return the repaired or replacement products to you. We will pay to ship the repaired or replaced products to you if you use an address in Canada. Otherwise, we will ship the product to you freight collect.

If we determine that the problem is not covered under this warranty, we will notify you and inform you of service alternatives that are available to you on a fee basis.

**NOTE:** Before you ship the product(s) to us, make sure to back up the data on the hard drive(s) and any other storage device(s) in the product(s). Remove any confidential, proprietary or personal information, removable media, such as floppy disks, CDs, or PC Cards. We are not responsible for any of your confidential, proprietary or personal information; lost or corrupted data; or damaged or lost removable media.

**During the remaining years following the first year of all limited warranties:** We will replace any defective part with new or refurbished parts, if we agree that it needs to be replaced. When you contact us, we will require a valid credit card number at the time you request a replacement part, but we will not charge you for the replacement part as long as you return the original part to us within 30 days after we ship the replacement part to you. If we do not receive the original part within 30 days, we will charge to your credit card the then-current standard price for that part.

We will pay to ship the part to you if you use an address in Canada. Otherwise, we will ship the part freight collect. We will also include a prepaid shipping container with each replacement part for your use in returning the replaced part to us.

**NOTE:** Before you replace parts, make sure to back up the data on the hard drive(s) and any other storage device(s) in the product(s). We are not responsible for lost or corrupted data.

## **What if I purchased a service contract?**

If your service contract is with Dell, service will be provided to you under the terms of the service contract. Please refer to that contract for details on how to obtain service. Dell's service contracts can be found online at [www.dell.ca](http://www.dell.ca) or by calling Customer Care at 1-800-847-4096. If you purchased through us a service contract with one of our third-party service providers, please refer to that contract (mailed to you with your packing slip or invoice) for details on how to obtain service.

## **How will you fix my product?**

We use new and refurbished parts made by various manufacturers in performing warranty repairs and in building replacement parts and systems. Refurbished parts and systems are parts or systems that have been returned to Dell, some of which were never used by a customer. All parts and systems are inspected and tested for quality. Replacement parts and systems are covered for the remaining period of the limited warranty for the product you bought. Dell owns all parts removed from repaired products.

## May I transfer the limited warranty?

Limited warranties on systems may be transferred if the current owner transfers ownership of the system and records the transfer with us. The limited warranty on Dell-branded memory may not be transferred. You may record your transfer by going to Dell's website:

- For Canada-purchased computers (in-country transfers) and to transfer from one customer to another, go to [www.dell.ca/ca/en/gen/topics/segtopic\\_ccare\\_nav\\_013\\_ccare.htm](http://www.dell.ca/ca/en/gen/topics/segtopic_ccare_nav_013_ccare.htm)
- For out-of-country transfers (outside of the original country of purchase), go to [www.dell.com/us/en/biz/topics/sbtopic\\_ccare\\_nav\\_016\\_ccare.htm](http://www.dell.com/us/en/biz/topics/sbtopic_ccare_nav_016_ccare.htm)

If you do not have Internet access, call Dell at 1-800-847-4096 (Home Consumer customers) or 1-800-326-9463 (Corporate Commercial or Government customers).

## "Total Satisfaction" Return Policy (Canada Only)

If you are an end-user customer who bought new products directly from Dell, you may return them to Dell up to 30 days after you receive them for a refund or credit of the product purchase price. If you are an end-user customer who bought reconditioned or refurbished products from Dell, you may return them to Dell within 14 days after the date on the packing slip or invoice for a refund or credit of the product purchase price. In either case, the refund or credit will not include any shipping and handling charges shown on your packing slip or invoice and will be subject to a fifteen percent (15%) restocking fee, unless otherwise prohibited by law. If you are an organization that bought the products under a written agreement with Dell, the agreement may contain different terms for the return of products than specified by this policy.

To return products, you must call Dell Customer Service at 1-800-847-4096 to receive a Credit Return Authorization Number. To expedite the process of your refund or credit, Dell expects you to return the products to Dell in their original packaging within 5 days of the date that Dell issues the Credit Return Authorization Number. You must also prepay shipping charges and insure the shipment or accept the risk of loss or damage during shipment. You may return software for a refund or credit only if the sealed package containing the floppy disk(s) or CD(s) is unopened. Returned products must be in as-new condition, and all of the manuals, floppy disk(s), CD(s), power cables, and other items included with a product must be returned with it. For customers who want to return, for refund or credit only, either application or operating system software that has been installed by Dell, the whole system must be returned, along with any media and documentation that may have been included in the original shipment.

The "Total Satisfaction" Return Policy does not apply to Dell | EMC storage products. It also does not apply to products purchased through Dell's Software and Peripherals division. For those products, please instead refer to Dell's Software and Peripheral's then-current return policy (see the following section, "Dell Software and Peripherals [Canada Only]").

## **Dell Software and Peripherals (Canada Only)**

### **Third-Party Software and Peripherals Products**

Similar to other resellers of software and peripherals, Dell does not warrant third-party products. Third-party software and peripheral products are covered by the warranties provided by the original manufacturer or publisher only. Third-party manufacturer warranties vary from product to product. Consult your product documentation for specific warranty information. More information may also be available from the manufacturer or publisher.

While Dell offers a wide selection of software and peripheral products, we do not specifically test or guarantee that all of the products we offer work with any or all of the various models of Dell computers, nor do we test or guarantee all of the products we sell on the hundreds of different brands of computers available today. If you have questions about compatibility, we recommend and encourage you to contact the third-party software and peripheral product manufacturer or publisher directly.

### **Dell-Branded Peripheral Products**

Dell does provide a limited warranty for new Dell-branded peripheral products (products for which Dell is listed as the manufacturer) such as monitors, batteries, memory, docking stations, and projectors. To determine which limited warranty applies to the product you purchased, see the Dell packing slip or invoice and/or the product documentation that accompanied your product. Descriptions of Dell's limited warranties are described in preceding sections.

### **Return Policy**

If you are an end-user customer who bought Dell Software and Peripherals products directly from a Dell company, you may return Dell Software and Peripherals products that are in as-new condition to Dell up to 30 days from the date on the packing slip or invoice for a refund of the product purchase price if already paid. This refund will not include any shipping and handling charges shown on your packing slip or invoice; you are responsible for those.

To return products, you must call Dell Customer Service at 1-800-387-5759 to receive a Credit Return Authorization Number. You must ship the Dell Software and Peripherals products back to Dell in their original manufacturer's packaging (which must be in as-new condition), prepay shipping charges, and insure the shipment or accept the risk of loss or damage during shipment.

To qualify for refund or replacement, returned products must be in as-new condition, software products must be unopened, and all of the manuals, floppy disk(s), CD(s), power cables, and other items included with a product must be returned with it.

# 1-Year End-User Manufacturer Guarantee (Latin America and the Caribbean Only)

## Guarantee

Dell Computer Corporation ("Dell") warrants to the end user in accordance with the following provisions that its branded hardware products, purchased by the end user from a Dell company or an authorized Dell distributor in Latin America or the Caribbean, will be free from defects in materials, workmanship, and design affecting normal use, for a period of 1 year from the original purchase date. Products for which proper claims are made will, at Dell's option, be repaired or replaced at Dell's expense. Dell owns all parts removed from repaired products. Dell uses new and reconditioned parts made by various manufacturers in performing repairs and building replacement products.

## Exclusions

This Guarantee does not apply to defects resulting from: improper or inadequate installation, use, or maintenance; actions or modifications by unauthorized third parties or the end user; accidental or willful damage; or normal wear and tear.

## Making a Claim

Claims must be made in Latin America or the Caribbean by contacting the Dell point of sale within the guarantee period. The end user must always supply proof of purchase, indicating name and address of the seller, date of purchase, model and serial number, name and address of the customer, and details of symptoms and configuration at the time of malfunction, including peripherals and software used. Otherwise, Dell may refuse the guarantee claim. Upon diagnosis of a warranted defect, Dell will make arrangements and pay for ground freight and insurance to and from Dell's repair/replacement center. The end user must ensure that the defective product is available for collection properly packed in original or equally protective packaging together with the details listed above and the return number provided to the end user by Dell.

## Limitation and Statutory Rights

Dell makes no other warranty, guarantee or like statement other than as explicitly stated above, and this Guarantee is given in place of all other guarantees whatsoever, to the fullest extent permitted by law. In the absence of applicable legislation, this Guarantee will be the end user's sole and exclusive remedy against Dell or any of its affiliates, and neither Dell nor any of its affiliates shall be liable for loss of profit or contracts, or any other indirect or consequential loss arising from negligence, breach of contract, or howsoever.

This Guarantee does not impair or affect mandatory statutory rights of the end user against and/or any rights resulting from other contracts concluded by the end user with Dell and/or any other seller.

**Dell World Trade LP**

One Dell Way, Round Rock, TX 78682, USA

**Dell Computadores do Brasil Ltda (CNPJ No. 72.381.189/0001-10)**

Avenida Industrial Belgraf, 400  
92990-000 - Eldorado do Sul – RS - Brasil

**Dell Computer de Chile Ltda**

Coyancura 2283, Piso 3- Of.302,  
Providencia, Santiago - Chile

**Dell Computer de Colombia Corporation**

Carrera 7 #115-33 Oficina 603  
Bogota, Colombia

**Dell Computer de Mexico SA de CV**

Paseo de la Reforma 2620 - 11° Piso  
Col. Lomas Altas  
11950 México, D.F.



# Glossary

**802.11 (Wi-Fi)** — A wireless technology standard for mid-range networking devices that allows for enabled devices to automatically recognize each other.

**BLUETOOTH® WIRELESS TECHNOLOGY** — A wireless technology standard for short-range (10 m [30 ft]) networking devices that allows for enabled devices to automatically recognize each other.

**COMPACTFLASH CARD** — A removable card that is used to expand the capabilities of a device. Common types of CompactFlash cards include memory and wireless cards.

**CRADLE** — A device that allows your handheld device to synchronize with a computer, recharge its battery, and run on AC power.

**DHCP** — dynamic host configuration protocol — A communication protocol that allows network administrators to manage and automate the assignment of Internet Protocol addresses to computers in a network.

**IMAP** — Internet message access protocol — A standard client/server protocol that allows you to access your e-mail from a server. Using IMAP, you can store and browse your e-mail on the server.

**INFRARED SENSOR** — A port that allows you to transfer data between the computer and infrared-compatible devices without using a cable connection.

**ISP** — Internet service provider — A company that allows you to access its host server to connect directly to the Internet, send and receive e-mail, and access websites. The ISP typically provides you with a software package, username, and access phone numbers for a fee.

**LAN** — local area network — A computer network covering a small area. A LAN usually is confined to a building or a few nearby buildings. A LAN can be connected to another LAN over any distance via telephone lines and radio waves to form a wide area network (WAN).

**PIM** — personal information manager — A program that stores and organizes your personal information, such as Calendar, Contacts, Messaging, and Tasks.

**POP3** — post office protocol 3 — A standard client/server protocol that allows you to access your e-mail from a server. Using POP3, you must download your e-mail to your local system to view and browse your messages.

**RAM** — random-access memory — The primary temporary storage area for program instructions and data. Any information stored in RAM is lost when you perform a reset.

**RAS** — remote access server — A type of server that allows users to access a network from a remote location.

**ROM** — read-only memory — Memory that stores data and programs that cannot be deleted or written to by the device. ROM, unlike RAM, retains its contents after you perform a reset. Some programs essential to the operation of your device reside in ROM.

**SDRAM** — synchronous dynamic random-access memory — A type of DRAM that is synchronized with the optimal clock speed of the microprocessor.

**SECURE DIGITAL MEMORY CARD** — A type of removable memory commonly used in digital cameras, handheld devices, cell phones, and other devices. Secure Digital memory cards are approximately the size of a postage stamp.

**SERIAL CONNECTOR** — An I/O port often used to connect devices such as a handheld digital device or digital camera to your computer.

**SMS** — short message service — A service that is capable of sending short messages to wireless devices.

**SMTP** — simple mail transfer protocol — A type of protocol used for sending and receiving e-mail. SMTP is typically coupled with POP3 or IMAP.

**SYNC CABLE** — A cable through which you can connect a handheld device to a computer to transfer or synchronize files.

**SYNCHRONIZATION** — An automated process that replaces the files in one location with the most updated files from another location. For example, you can synchronize the files on your computer with the files on your handheld device.

**TCP/IP** — transmission control protocol/Internet protocol — The basic communication language of the Internet. TCP/IP can also be used as a communication protocol in an intranet or extranet.

**USB** — universal serial bus — A hardware interface for a low-speed device such as a USB-compatible keyboard, mouse, joystick, scanner, set of speakers, printer, broadband devices (DSL and cable modems), imaging devices, or storage devices. Devices are plugged directly into a 4-pin socket on your computer or into a multiport hub that plugs into your computer. USB devices can be connected and disconnected while the computer is turned on, and they can also be daisy-chained together.

**VPN** — virtual private network — A set of communication protocols that allows remote users to securely access a network.

**WAP** — wireless application protocol — A standardization for the way that wireless devices access the Internet.



# Index

## A

- ActiveSync
  - about, 55
  - installing, 56
- appointments
  - scheduling, 58
- audio
  - Media player, 83
  - notifications, 69
- AvantGo
  - about, 87

## B

- battery
  - charging, 22
  - main, 20
  - using and installing, 20
- block recognizer, 45
- Bluetooth
  - settings, 54

## buttons

- about, 35
- Calendar, 18
- Contacts, 18
- Home, 18
- locations, 17
- navigator, 18
- power, 18
- program buttons, 38
- record, 18
- reset, 19

## C

- Calendar
  - about, 57
  - appointments, 58
  - meeting requests, 59
- command bar, 40
- communicating
  - with other devices, 91
- CompactFlash
  - about, 29
  - installing, 30
  - slot, 17

computer  
connecting to, 23, 28

Contacts  
about, 60  
creating, 60  
finding, 61

cradle  
connecting to a computer, 23

## D

data  
backing up, 42

disconnecting  
dial-up connection, 97  
from a cable or cradle, 97  
from a network, 97  
infrared sensor, 97

drawing  
creating, 50

## E

editing  
written text, 47

e-mail  
composing messages, 67  
connecting to a server, 64, 97  
message list, 65  
Messaging, 64  
organizing, 68  
synchronizing, 64

ethernet connection, 95

Excel  
about, 79  
tips, 81

expansion slots  
CompactFlash, 29  
locations, 17

## F

File Download Security  
Warning, 75

files  
backing up, 42  
File Explorer, 73  
finding, 73  
finding and organizing, 41  
synchronizing, 55

finding information, 15  
contacting Dell, 125

## H

help  
ActiveSync Help, 98  
contacting Dell, 125  
finding, 98  
Pocket PC Help, 15

## I

icons  
program, 39  
status, 36

- infrared
  - using, 91
- input panel, 43
- Internet
  - connecting to, 91
- Internet Explorer
  - about, 85
  - browsing the web, 88
  - favorite links, 87
  - mobile favorites, 85-86

## **K**

- keyboard
  - soft, 44

## **L**

- letter recognizer, 45

## **M**

- Media Player
  - about, 83
- meeting requests
  - creating, 59
- memory
  - conserving, 86
- Messaging
  - about, 64

- microphone
  - recording a message, 51
- modem connection, 94
- MSN Messenger
  - about, 81
  - setting up, 82
  - working with contacts, 82
- My Text
  - inserting, 52

## **N**

- navigation bar, 40
- network
  - connecting to, 91
- Notes
  - creating, 63
- notifications
  - about, 69

## **P**

- Pocket Outlook
  - about, 57
- Pocket PC
  - getting started, 35
- pop-up menus, 41
- print-style text
  - converting written text to, 45

programs  
  accessing, 38  
  ActiveSync, 55  
  adding and removing, 71  
  adding programs using  
    ActiveSync, 71  
  AvantGo, 87  
  Calendar, 57  
  Contacts, 60  
  downloading, 72  
  Media Player, 83  
  Messaging, 64  
  MSN Messenger, 81  
  Notes, 63  
  Pocket Excel, 79  
  Pocket Internet Explorer, 85  
  Pocket Outlook, 57  
  Pocket Word, 77  
  removing, 75  
  Start menu, 73  
  Switcher Bar, 38  
  Tasks, 61

projector, 28

## R

recording  
  voice messages, 51

reminders. *See* notifications

reset  
  button, 19  
  performing, 32

resources  
  finding, 15

## S

safety instructions, 11

Secure Digital card slot  
  installing cards, 31  
  location, 17

Service Tag, 15, 22

settings  
  adjusting, 53  
  Connections tab, 54  
  Personal tab, 53  
  System tab, 53

software. *See* programs

specifications, 99

stylus  
  using, 35  
  writing methods, 43

Switcher Bar, 38

sync cable  
  connecting to a computer, 27

synchronizing  
  with your computer, 23

## T

### Tasks

- about, 61
- creating, 61

### text

- converting written text to
  - print-style text, 45
- editing, 46-47
- input panel, 43
- typing, 44
- written, 45-46

### Today screen, 35

### transcriber, 45

## V

### video

- Media Player, 83

### VPN connection, 96

## W

### warranty, 109, 153

### Word

- about, 77

### writing

- block recognizer, 45
- converting written text to
  - print-style text, 45
- drawing, 50
- editing, 46
- letter recognizer, 45
- methods, 43
- on the screen, 46
- transcriber, 45

